

10200 West York Street/Wichita, Kansas 67215 U.S.A./ (316) 522-4981/TWX 910-741-6952

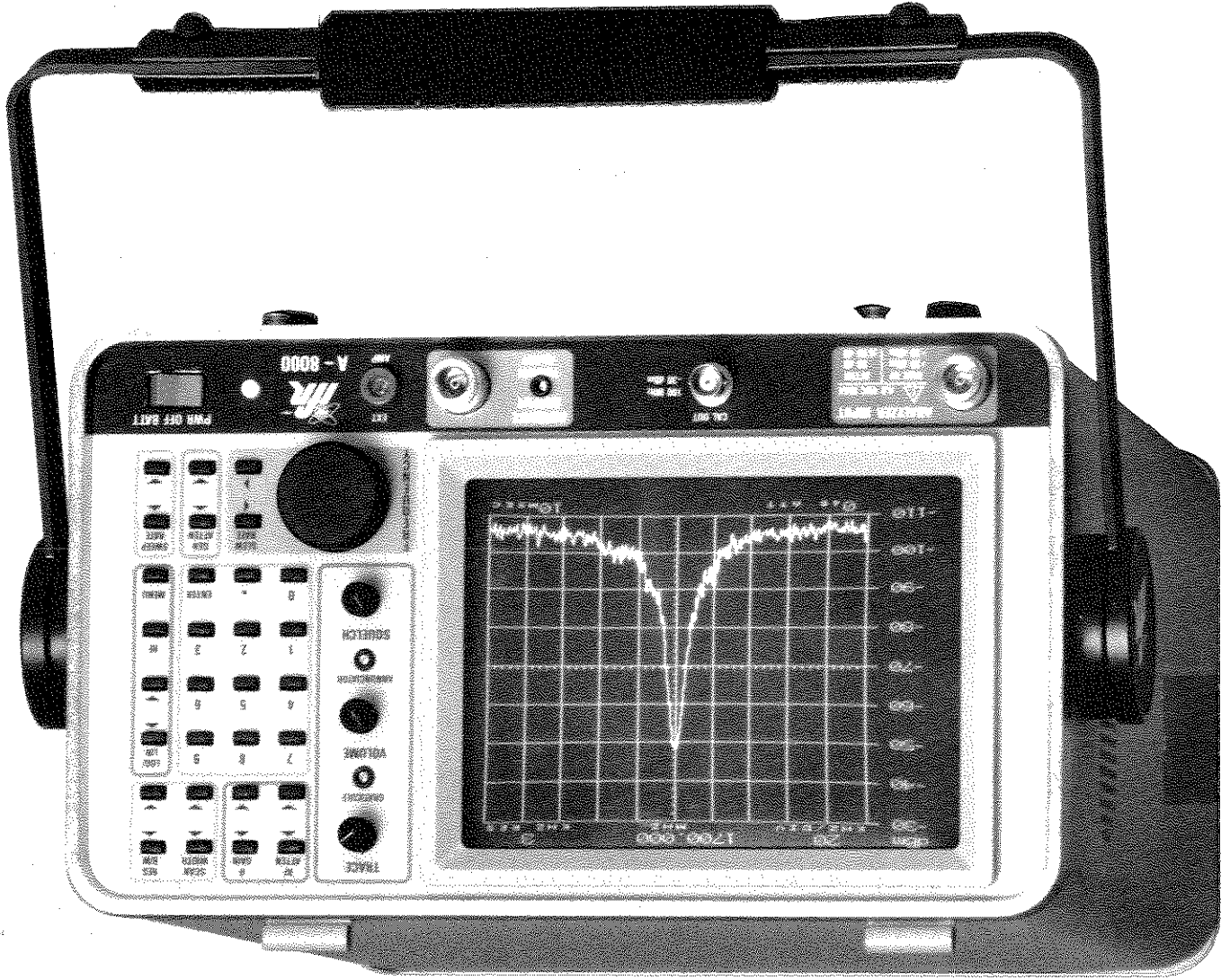

A-8000 SPECTRUM ANALYZER

OPERATION MANUAL

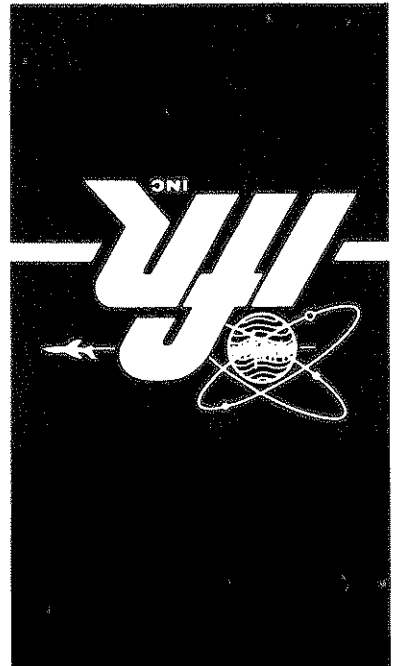

PUBLISHED BY
IFR SYSTEMS, INC.
Wichita, Kansas

COPYRIGHT © 1989 by IFR SYSTEMS, INC.

All rights reserved. Printed in the United States of America. No part of this publication may be reproduced in a retrieval system, or transmitted in any form or by any means, electronic, mechanical, photocopying, recording or otherwise without the prior permission of the publisher.

WARNING:

HIGH VOLTAGE EQUIPMENT

THIS EQUIPMENT CONTAINS CERTAIN CIRCUITS AND/OR COMPONENTS OF EXTREMELY HIGH VOLTAGE POTENTIALS, CAPABLE OF CAUSING SERIOUS BODILY INJURY OR DEATH. WHEN PERFORMING ANY OF THE PROCEDURES CONTAINED IN THIS MANUAL, HEED ALL APPLICABLE SAFETY PRECAUTIONS.

RESCUE OF SHOCK VICTIMS

1. DO NOT ATTEMPT TO PULL OR GRAB THE VICTIM
2. IF POSSIBLE, TURN OFF THE ELECTRICAL POWER.
3. IF YOU CANNOT TURN OFF ELECTRICAL POWER, PUSH, PULL OR LIFT THE VICTIM TO SAFETY USING A WOODEN POLE, A ROPE OR SOME OTHER DRY INSULATING MATERIAL.

FIRST AID

1. AS SOON AS VICTIM IS FREE OF CONTACT WITH SOURCE OF ELECTRICAL SHOCK, MOVE VICTIM A SHORT DISTANCE AWAY FROM SHOCK HAZARD.
2. SEND FOR DOCTOR AND/OR AMBULANCE.
3. KEEP VICTIM WARM, QUIET AND FLAT ON HIS/HER BACK.
4. IF BREATHING HAS STOPPED, ADMINISTER ARTIFICIAL RESUSCITATION. STOP ALL SERIOUS BLEEDING.

INTEGRATED CIRCUITS AND SOLID STATE DEVICES SUCH AS MOS FET'S, ESPECIALLY CMOS TYPES, ARE SUSCEPTIBLE TO DAMAGE BY ELECTROSTATIC DISCHARGES RECEIVED FROM IMPROPER HANDLING, THE USE OF UNGROUNDED TOOLS, AND IMPROPER STORAGE AND PACKAGING. ANY MAINTENANCE TO THIS UNIT MUST BE PERFORMED WITH THE FOLLOWING PRECAUTIONS:

1. BEFORE USING IN A CIRCUIT, KEEP ALL LEADS SHORTED TOGETHER EITHER BY THE USE OF VENDOR-SUPPLIED SHORTING SPRINGS OR BY INSERTING LEADS INTO A CONDUCTIVE MATERIAL.
2. WHEN REMOVING DEVICES FROM THEIR CONTAINERS, GROUND THE HAND BEING USED WITH A CONDUCTIVE WRISTBAND.
3. SOLDERING IRONS AND/OR ANY TOOLS USED MUST BE GROUNDED.

4. DEVICES MUST NEVER BE INSERTED INTO NOR REMOVED FROM CIRCUITS WITH POWER ON.

5. PC BOARD, WHEN TAKEN OUT OF THE SET, MUST BE LAID ON A GROUNDED CONDUCTIVE MAT OR STORED IN A CONDUCTIVE STORAGE BAG.

NOTE

Remove any built-in power source, such as a battery, before laying PC Boards on conductive mat or storing in conductive bag.

6. PC BOARDS, IF BEING SHIPPED TO THE FACTORY FOR REPAIR, MUST BE PACKAGED IN A CONDUCTIVE BAG AND PLACED IN A WELL-CUSHIONED SHIPPING BOX.

CAUTION

LIST OF EFFECTIVE PAGES

The manual pages listed below which are affected by a current change or revision, are so identified by a revision number and an asterisk.

Date of issue for original and changed pages are:

Original	0	May 1, 1987
Revision	1	September 15, 1987
Revision	2	April 15, 1989

TOTAL NUMBER OF PAGES IN THIS MANUAL IS 148 CONSISTING OF FOLLOWING:

Pg. No.	Change No.	Pg. No.	Change No.
Title	0	4-18 thru 4-22	1
*Copyright	2	5-1 thru 5-15	0
Warning	0	5-16 Blank	0
Caution	0	6-1 thru 6-8	0
*A	2	6-9	2
B Blank	0	6-10 thru 6-17	0
i thru iii	0	6-18 Blank	0
iv	1	7-1 thru 7-3	0
v thru vi	0	*7-4	2
vii	1	7-5 thru 7-12	0
viii thru ix	0	8-1 thru 8-9	0
x Blank	0	8-10 Blank	0
*1-1 thru 1-3	2	*A-1 thru A-6	2
1-4 Blank	0	B-1 thru B-5	0
2-1 thru 2-2	0	B-6 Blank	0
2-3	1	C-1	0
2-4 Blank	0	C-2 Blank	0
3-1 Blank	0	D-1 thru D-3	0
3-2 thru 3-18	0	D-4 Blank	0
4-1 Blank	0	E-1 thru E-4	0
4-2 thru 4-5	1	F-1 thru F-2	0
4-6 thru 4-13	0	G-1 thru G-3	0
4-14	1	G-4 Blank	0
4-15 thru 4-17	0		

33525-

SCOPE

1306/12458

PREPARE

3.40
A-8000

This manual contains instructions and procedures for operating the A-8000 Spectrum Analyzer. It is strongly recommended that the operator be thoroughly familiar with sections 1 through 4 of this manual before attempting to operate the A-8000.

CUSTOMER SERVICE ASSISTANCE

Before contacting the IFR Customer Service Center, have the model, serial number and software version of your unit available beforehand. This will facilitate handling of your problem.

ORGANIZATION

This operation manual is divided into the following major sections:

SECTION 1 - INTRODUCTION

Provides a brief description of the A-8000 standard and optional features.

SECTION 2 - INSTALLATION

Provides step-by-step procedures for preparing the A-8000 for operation.

SECTION 3 - DESCRIPTION OF CONTROLS, CONNECTORS AND INDICATORS

Identifies and functionally describes all A-8000 controls, connectors and indicators.

NOTE

As an operating aid, Figure 3-1 (which locates and identifies all A-8000 front panel controls) is included as a fold-out page. By extending this page, the operator can easily reference any front panel control while simultaneously performing the operating procedures in this manual.

SECTION 4 - MENU OPERATION

Contains instructions for operating the A-8000 Spectrum Analyzer Menus. For operator convenience, the menu hierarchy is shown in Figure 4-1 as an extended page.

SECTION 5 - BASIC OPERATING PROCEDURES

Contains quick, qualitative, step-by-step procedures for assessing the performance of the A-8000.

SECTION 6 - GPIB OPERATION

Provides instructions for A-8000/GPIB interface.

SECTION 7 - RS-232 OPERATION

Provides instructions for A-8000/RS-232 interface.

DEFINITION

DEFINITION

(FORM)

Supplementary information relating to A-8000 operation is contained in appendices. (See Table of Contents for detailed list of appendices.)

SECTION 8 - QUASI-PEAK OPERATION
Provides instructions for taking Quasi-Peak measurements with the A-8000.

TABLE OF CONTENTS

Page	Title	Paragraph
A	List of Effective Pages	
i	Preface	
iii	Table of Contents	
vii	List of Illustrations	
ix	List of Tables	

SECTION 1 - INTRODUCTION

1-1	General	1-1
1-1	Standard Features	1-2
1-1	Display Method	1-2-1
1-1	Measurements with the A-8000 Spectrum Analyzer	1-2-2
1-1	Optimum Input Level	1-2-3
1-2	Optional Features	1-3
1-2	Battery - Option 01	1-3-1
1-2	Tracking Generator With 0-70 dB Attenuator - Option 02	1-3-2
1-2	+20 dB External Amplifier - Option 03	1-3-3
1-2	10.7 MHz FM/AM Receiver - Option 04	1-3-4
1-2	GP1B - Option 05; RS-232 - Option 06	1-3-5
1-2	50Ω/75Ω Selectable Impedance - Option 07	1-3-6
1-3	Quasi-Peak Filter - Option 08	1-3-7
1-3	Maintenance Kit - Option 09	1-3-8
1-3	Camera Mount Adapter - Option 10	1-3-9
1-3	Carrying Case - Option 11	1-3-10

SECTION 2 - INSTALLATION

2-1	Initial Unit Check	2-1
2-1	Installation and Operation Precautions	2-2
2-2	Preparation for Use	2-3
2-2	External AC Power	2-3-1
2-2	External DC Power	2-3-2
2-2	Internal Battery Power	2-3-3
2-3	Clearing the Display	2-4

SECTION 3 - DESCRIPTION OF CONTROLS, CONNECTORS AND INDICATORS

3-1	Front Panel	3-1
3-2	Rear Panel	3-2
3-3	CRT Display	3-3
3-3-1	CRT Display Values	3-3-1
3-3-1-1	Scan Width Display	3-3-1-1
3-3-1-2	Center Frequency Display	3-3-1-2
3-3-1-3	Bandwidth Display	3-3-1-3
3-3-1-4	Menu Display	3-3-1-4
3-3-1-5	Sweep Rate Display	3-3-1-5
3-2	Front Panel	3-1
3-4	Rear Panel	3-2
3-7	CRT Display	3-3
3-7	CRT Display Values	3-3-1
3-7	Scan Width Display	3-3-1-1
3-8	Center Frequency Display	3-3-1-2
3-8	Bandwidth Display	3-3-1-3
3-8	Menu Display	3-3-1-4
3-8	Sweep Rate Display	3-3-1-5

4-1	Menus	4-1
4-1-1	Menu Levels	4-1-1
4-1-2	Menu Operation Notes	4-1-2
4-2	Master Menu	4-2
4-3	Display (DISP) Menu	4-3
4-4	MODE Menu	4-4
4-5	RCVR Menu	4-5
4-6	FILTERS Menu	4-6
4-6-1	Video Filter Indicator	4-6-1
4-6-2	Filters Menu Selection	4-6-2
4-6-3	QUASI-PEAK Filter Menu	4-6-3
4-7	SETUP Menu	4-7
4-8	REMOTE Menus	4-8
4-8-1	GPIB Menu	4-8-1
4-8-2	RS-232 Menu	4-8-2
4-9	MANUAL Menu	4-9
4-10	TEST Menu	4-10
4-11	PLOT/PRINT Menus	4-11
4-11-1	Plotter/Printer Installation	4-11-1
4-11-2	Plotter Operation	4-11-2
4-11-3	PLOT Menu Functions	4-11-3
4-11-4	Printer Operation	4-11-4
4-11-5	Printer Menu Functions	4-11-5
4-12	OPTION NOT INSTALLED Menu	4-12

SECTION 4 - MENU OPERATION

3-1-6	RF Attenuation Display	3-3-1-6
3-1-7	Tracking Generator Output Display	3-3-1-7
3-1-8	Graticules/dB Scale Labels	3-3-1-8
3-1-9	Graticule Unit Display	3-3-1-9
3-2	Special Display Messages and Indicators	3-3-2
3-2-1	UNCAL Message	3-3-2-1
3-2-2	UNLCK Message	3-3-2-2
3-2-3	AC Indicator (Ac)	3-3-2-3
3-2-4	Manual Bandwidth Indicator (M+)	3-3-2-4
3-2-5	Manual Sweep Rate Indicator (M+)	3-3-2-5
3-2-6	Full Scan Indicator (FULL)	3-3-2-6
3-2-7	Video Filter Indicator (VF 30K or VF 300)	3-3-2-7
3-4	Keyboard	3-4
3-4-1	RF ATTN Keys	3-4-1
3-4-2	IF GAIN Keys	3-4-2
3-4-3	SCAN WIDTH Keys	3-4-3
3-4-4	RES B/W Keys	3-4-4
3-4-5	LOG/LIN Keys	3-4-5
3-4-6	NUMERIC Keys	3-4-6
3-4-7	RF/ENTER Keys	3-4-7
3-4-8	MENU Key	3-4-8
3-4-9	SWEEP RATE Keys	3-4-9
3-4-10	GEN ATTN Keys	3-4-10
3-4-11	SLEW RATE Keys	3-4-11
3-4-12	FREQUENCY Control	3-4-12

8-1	Quasi-Peak Purpose	8-1
8-1	Quasi-Peak Prerequisites	8-2
8-1	Units	8-2-1
8-1	Linear Mode	8-2-2
8-2	Scan Width Selection	8-2-3
8-2	Continuous Wave Signals	8-2-4
8-4	Time Constants	8-2-5
8-4	Line Impedance Stabilization Networks (LISN)	8-2-6
8-4	Antenna Factor	8-2-7
8-5	Quasi-Peak Measurement Procedure	8-3

SECTION 8 - QUASI-PEAK OPERATION

7-1	Remote Control (RS-232) Operation	7-1
7-1	Preparation for Using RS-232	7-1-1
7-2	Command and Data Structure	7-2
7-2	RS-232 Commands to the A-8000	7-2-1
7-2	RS-232 Command Data Format	7-2-2
7-3	Return Data Format	7-2-3
7-4	Reply Identifier	7-2-4
7-4	A-8000 Command Set	7-3

SECTION 7 - RS-232 OPERATION

6-1	Remote (GPB) Operation	6-1
6-1	Preparation for Using GPB	6-1-1
6-2	A-8000 and GPB Message Interface	6-1-2
6-4	GPB Transactions	6-1-3
6-5	Status and Service Request Transactions	6-1-4
6-6	Command and Data Structure	6-2
6-6	GPB Commands to the A-8000	6-2-1
6-6	GPB Command Data Format	6-2-2
6-7	Return Data Format	6-2-3
6-8	Reply Identifier	6-2-4
6-9	A-8000 Command Set	6-3

SECTION 6 - GPB OPERATION

5-1	General	5-1
5-2	A-8000 Operation Procedures	5-2
5-2	Procedure for Standard A-8000 Unit	5-2-1
5-10	75Ω Operation Procedure	5-2-2
5-12	10.7 MHz FM/AM Receiver Operation Procedure	5-2-3
5-14	Tracking Generator Operation Procedure	5-2-4

SECTION 5 - BASIC OPERATION PROCEDURES

Appendix A	A-8000 Performance Specifications	A-1
Appendix B	Capturing A-8000 Analyzer Traces	B-1
Appendix C	A-8000 Signal Amplitude Values in Linear Mode	C-1
Appendix D	Resolution Bandwidth	D-1
Appendix E	Optimization of Resolution Bandwidths and Sweep Rates	E-1
Appendix F	Repacking For Shipment	F-1
Appendix G	Abbreviations	G-1

APPENDICES

LIST OF ILLUSTRATIONS

Figure No.	Title	Page
2-1	IFR Logo Display	2-3
3-1	A-8000 Front Panel Controls, Connectors and Indicators	3-2
3-2	A-8000 Rear Panel	3-2
3-3	Interaction of CRT Display and Keyboard	3-4
3-4	Frequency Slew Digit Selection	3-7
3-5	Center Frequency Display with SLEW RATE Cursor Illuminated	3-18
4-1	Menu Access in Menu Operation	3-18
4-2	Master Menu	4-2
4-3	Display (DISP) Menu	4-4
4-4	MODE Menu	4-5
4-5	RCVR Menu	4-6
4-6	FILTERS Menu	4-8
4-7	QUASI-PEAK Menu	4-9
4-8	SETUP Menu	4-10
4-9	GPB Menu	4-12
4-10	RS-232 Menu	4-14
4-11	MANUAL Menu	4-15
4-12	TEST Menu	4-16
4-13	PLOT Menu	4-17
4-14	PRINT Menu	4-19
4-15	OPTION NOT INSTALLED Menu	4-21
4-16	REF OUT Signal Display	4-22
5-1	LIVE Trace to be Stored	5-5
5-2	Signal with 30 dB RF ATEN	5-7
5-3	Compare Mode Display: STORED vs. LIVE TRACE	5-8
5-4	REF Mode Display (20 dB ATEN Difference)	5-9
5-5	REF Mode Signal Display	5-9
5-6	Tracking Generator Display	5-10
5-7	GPB Connector	5-14
6-1	IEEE 488-1978 Display Output	6-2
6-2	RS-232 Interface Connector	6-8
7-1	Linear Scale	7-1
8-1	TC1 Amplitude Error (Frequency Range: 10 to 150 KHz)	8-2
8-2	TC2 Amplitude Error (Frequency Range: 150 KHz to 30 MHz)	8-3
8-3	TC3 Amplitude Error (Frequency Range: 30 MHz to 1 GHz)	8-3
8-4	Line Impedance Stabilization Network (LISN)	8-3
8-5	Initial Background or Ambient Signals	8-4
8-6	Reference Display with Ambient Signals Zeroed	8-5
8-7	Reference Display with UUT Turned On	8-6
8-8	Signal of Interest at 100 MHz	8-7
8-9	UUT Readout in Linear Mode	8-8
8-10	Frequency in Question Before Quasi-Peak	8-8
8-11	Frequency in Question with Quasi-Peak Activated	8-8
8-12	Frequency in Question with Quasi-Peak Activated	8-9

D-1	Determining the Resolution Bandwidth on	D-1
D-2	Filter Response Curve	D-2
D-2	Resolution Bandwidth Setting 30 KHz (20 KHz Sidebands	D-2
D-3	Not Visible)	D-3
D-3	Reset Resolution Bandwidth to 3 KHz (20 KHz Sidebands	D-3
D-2	Visible)	D-2
D-2	Composite of Figures D-2 and D-3	D-2
D-3	Obstructed Signal Due to Noise Floor	D-3
D-3	Reducing Bandwidth Drops to Noise Floor To Show Signals ..	D-3
F-2	Repacking for Shipment	F-2

LIST OF TABLES

Page	Title	Table No.
3-9	A-8000 Units Comparison	3-1
3-11	A-8000 Keyboard Quick Reference	3-2
3-12	Interaction of RF ATTEN and IF GAIN	3-3
3-13	Maximum Selectable Scan Widths at Allowable A-8000 CF Settings	3-4
6-1	Pinout for GPIB Connector	6-1
6-2	IEEE 488-1978 Bus Messages	6-2
6-3	Status Bit Definition	6-3
6-4	A-8000 Instruction Set	6-4
7-1	RS-232 Connector Pinout	7-1
7-2	A-8000 Instruction Set	7-2
8-1	Optimum Sweep Rates for TC2 and TC3	8-1
8-2	Quasi-Peak Time Constants	8-2
C-1	A-8000 Signal Amplitude (A) Values for X = 20 Log (D ÷ 8)	C-1
E-1	Optimal Resolution Bandwidth Settings	E-1
E-2	Sweep Rate Optimization with No Video Filter	E-2
E-3	Sweep Rate Optimization with 300 Hz Video Filter	E-3
E-4	Sweep Rate Optimization with 30 KHz Video Filter	E-4

LIST OF TABLES

ix/x Blank

1-1 GENERAL

The A-8000 Spectrum Analyzer is a microprocessor-controlled, super-heterodyne unit which features ease of operation, while providing the features of a full-function spectrum analyzer.

1-2 STANDARD FEATURES

The A-8000 Spectrum Analyzer covers a range from 10 kHz to 2600 MHz at signal levels up to +30 dBm. Signal levels are read directly on the CRT graphic display in dBm, dBW, dBV, dBmV or dBuV. Signals can be stored and recalled or used for comparison purposes. Standard A-8000 input impedance is 50Ω. All operating parameters are set via keyboard operation.

1-2-1 DISPLAY METHOD

The A-8000 Spectrum Analyzer display is fully digitized. A vertical Raster Scan (VRS_{TM}) method is used to form the display of 390 horizontal discrete points by 480 vertical points. The "FULL" Scan display range is from -50 MHz to 2600 MHz.

1-2-2 MEASUREMENTS WITH THE A-8000 SPECTRUM ANALYZER

The A-8000 Spectrum Analyzer can be used for a wide variety of measurements within its frequency/amplitude domain. Some of the more important uses include: spectral purity, mixer products, modulation measurements, carrier suppression in single Side Band radios, harmonic levels, RF carrier levels, distortion and, with the Quasi-Peak filter, electro-magnetic interference (EMI) measurements. When equipped with a Tracking Generator, additional measurements can be performed, including: insertion loss, frequency response and return loss (VSWR).

1-2-3 OPTIMUM INPUT LEVEL

Maximum input level to the A-8000 is +30 dBm (1 watt), if and only if 60 dB RF Attenuation is selected. Some degradation of amplitude accuracy occurs if high input levels are introduced to the A-8000 receiver.

CAUTION

SIGNALS EXCEEDING THE MAXIMUM INPUT LEVEL CAN CAUSE DAMAGE TO THE UNIT.

1-3 OPTIONAL FEATURES

The features described in the following subparagraphs are available with the A-8000 Spectrum Analyzer.

1-3-1 BATTERY - OPTION 01

The battery allows the A-8000 to operate for approximately 30 minutes without an external power source.

1-3-2 TRACKING GENERATOR WITH 0 TO 75 DB ATTENUATOR - OPTION 02

The tracking generator provides an RF signal at the same rate and the same frequency as the A-8000 analyzer. Maximum output level is 0 dbm. The output signal may be attenuated from 0 to -75 dbm in 1 db steps.

1-3-3 +20 DB EXTERNAL AMPLIFIER - OPTION 03

This device may be connected to the EXT AMP Connector and the GENERATE OUTPUT Connector to increase Tracking Generator output level by 20 db.

NOTE

Frequencies can be accurately amplified only between 10 KHZ and 1 GHZ.

1-3-4 10.7 MHZ FM/AM RECEIVER - OPTION 04

The demodulated audio from the receiver can be monitored through the speaker during zero scan operation, or on a time shared basis (see paragraph 4-5).

1-3-5 GPIB - OPTION 05; RS-232 - OPTION 06

The GPIB enables external control of the A-8000 via a GPIB type bus. The RS-232 enables external control of the A-8000 via an RS-232 type bus. Both options provide communication facilities needed for fully automated testing. Only one option can be installed in the unit at a time.

1-3-6 50Ω/75Ω SELECTABLE IMPEDANCE - OPTION 07

The input impedance may be manually changed from 50Ω to 75Ω by connecting a 50-to-75Ω Adapter to the ANALYZER INPUT Connector. The graphical labels for correct readout in 75Ω operation are changeable via menu operation. A second 50-to-75Ω Adapter must be used for 75Ω Tracking Generator operation.

1-3-7 QUASI-PEAK FILTER - OPTION 08

With Quasi-Peak, the A-8000 becomes an EMI (Electro-Magnetic Interference) measurement device. Peak and Quasi-Peak modes are selected through menu operation.

1-3-8 MAINTENANCE KIT - OPTION 09

The maintenance kit includes two ribbon cables, one PC board and one extender board.

1-3-9 CAMERA MOUNT ADAPTER - OPTION 10

The Camera Mount Adapter fits over the CRT screen to provide a photographic environment for CRT displays. It is used with the Tektronix Model C-4 camera.

1-3-10 CARRYING CASE - OPTION 11

The carrying case protects the A-8000 during transport or storage.

SECTION 2 - INSTALLATION

2-1 INITIAL UNIT CHECK

Before attempting to take measurements with the A-8000 Spectrum Analyzer, read Section 1 through Section 4 of this manual and perform the operating procedures in Section 5.

2-2 INSTALLATION AND OPERATION PRECAUTIONS

To prevent possible damage to the A-8000, the following power input and general operating precautions should be observed at all times:

CAUTION

ANALYZER INPUT CONNECTOR:
MAXIMUM INPUT INTO THIS CONNECTOR MUST NOT EXCEED 4 VDC, +30 dBm FOR INPUT ATTENUATOR SETTING OF 60 dB, AND +20 dBm FOR ALL OTHER ATTENUATOR SETTINGS.

GENERATE OUTPUT CONNECTOR:
THIS CONNECTOR IS USED WHEN TRACKING GENERATOR OPTION (02) IS INSTALLED IN A-8000. DO NOT APPLY SIGNAL INPUT THROUGH THIS CONNECTOR.

INTENSITY:
DO NOT OPERATE CRT DISPLAY WITH EXCESSIVE INTENSITY.

PWR/OFF/BATT SWITCH:
TO PROVIDE MAXIMUM PROTECTION OF NON-VOLATILE MEMORY CONTENTS, OBSERVE THE FOLLOWING:

1. Allow a minimum of five seconds between selection of "PWR" and "OFF" positions. Do not rapidly cycle power on and off.

2. Ensure electrical power is not removed from A-8000 when the ANALYZER INPUT connector has an input signal level > 0 dbm.

Other than the input power and operating precautions described above, any combination of front panel control positions will not adversely affect the A-8000.

Preparing the A-8000 for operation consists of the following:

1. Stand the A-8000 on its feet (on the back of the unit). With the cover latch facing towards you, pull the pivot points of the stand out about $\frac{1}{2}$ " from both sides of the unit and rotate it towards you 90°. Release the pivots so they lock into place. The A-8000 can then be positioned on this stand for operation.
2. Unlatch the front cover and remove or pivot it out of the way. The power cords that can be used (AC and DC) are inside the cover. Slide the inside cover latch down to open it and remove the desired cord.
3. Apply electrical power to A-8000 per applicable subparagraph below.

2-3-1 EXTERNAL AC POWER

1. The A-8000 operates from 106 to 266 VAC, 50 to 400 Hz.
2. Connect furnished AC power cable between 106 to 266 VAC power source and AC Power Input connector on rear panel of A-8000.
3. Set PWR/OFF/BATT switch to "PWR".

2-3-2 EXTERNAL DC POWER

1. The A-8000 operates from 12-30 VDC. The furnished cable is intended for use with a cigarette lighter socket.
2. Connect furnished DC power cable between external 12-30 VDC power source and DC Power Input Connector on rear panel of A-8000.
3. Set PWR/OFF/BATT switch to "PWR".

2-3-3 INTERNAL BATTERY POWER (OPTIONAL)

1. The internal battery can furnish up to 30 minutes of remote operation where external AC or DC is not available.
2. Push PWR/OFF/BATT switch to "BATT".

NOTE

The "BATT" position of the switch is spring loaded to the "OFF" position.

Whenever the A-8000 is first powered up, the IFR logo should appear on the CRT display as shown in Figure 2-1. After a short period of time following power-up, the logo is automatically cleared from the display. Pressing any button on the keyboard can also be used to clear the display. The analyzer is then ready for operation. Refer to Section 3 for Control Operating Procedures and Section 4 for Menu Operating Procedures.

The version indicated at the bottom of the Logo Display reflects the software version in the unit.

NOTE

Figure 2-1 IFR Logo Display

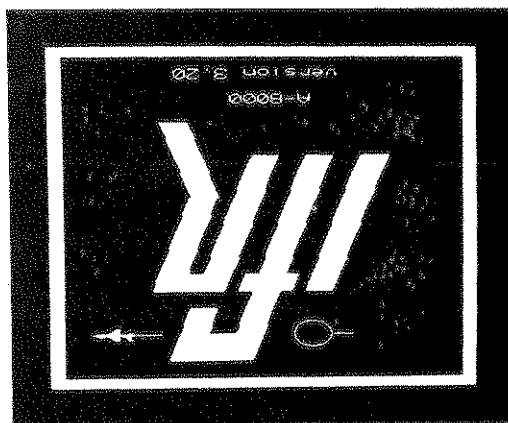

The A-8000 is operable immediately upon power-up. However, for optimum operation at specifications, allow a ten minute warm-up period.

NOTE

2-4 CLEARING THE DISPLAY

3. An internal timer circuit shuts off battery power after approximately 10 minutes of operation. The PWR/OFF/BATT Switch may be set to "BATT" again for further operation.
4. An internal low-voltage circuit discontinues battery operation if battery voltage drops below approximately 11.4 VDC.
5. The internal battery is rechargeable. Connect the test set to an external AC or DC power supply. A full charge requires at least 12 hours with a minimum external input of 15 VDC or 110 VAC.

SECTION 3 - DESCRIPTION OF CONTROLS, CONNECTORS AND INDICATORS

3-1 FRONT PANEL

Refer to Figure 3-1 to locate the following on the Front Panel.

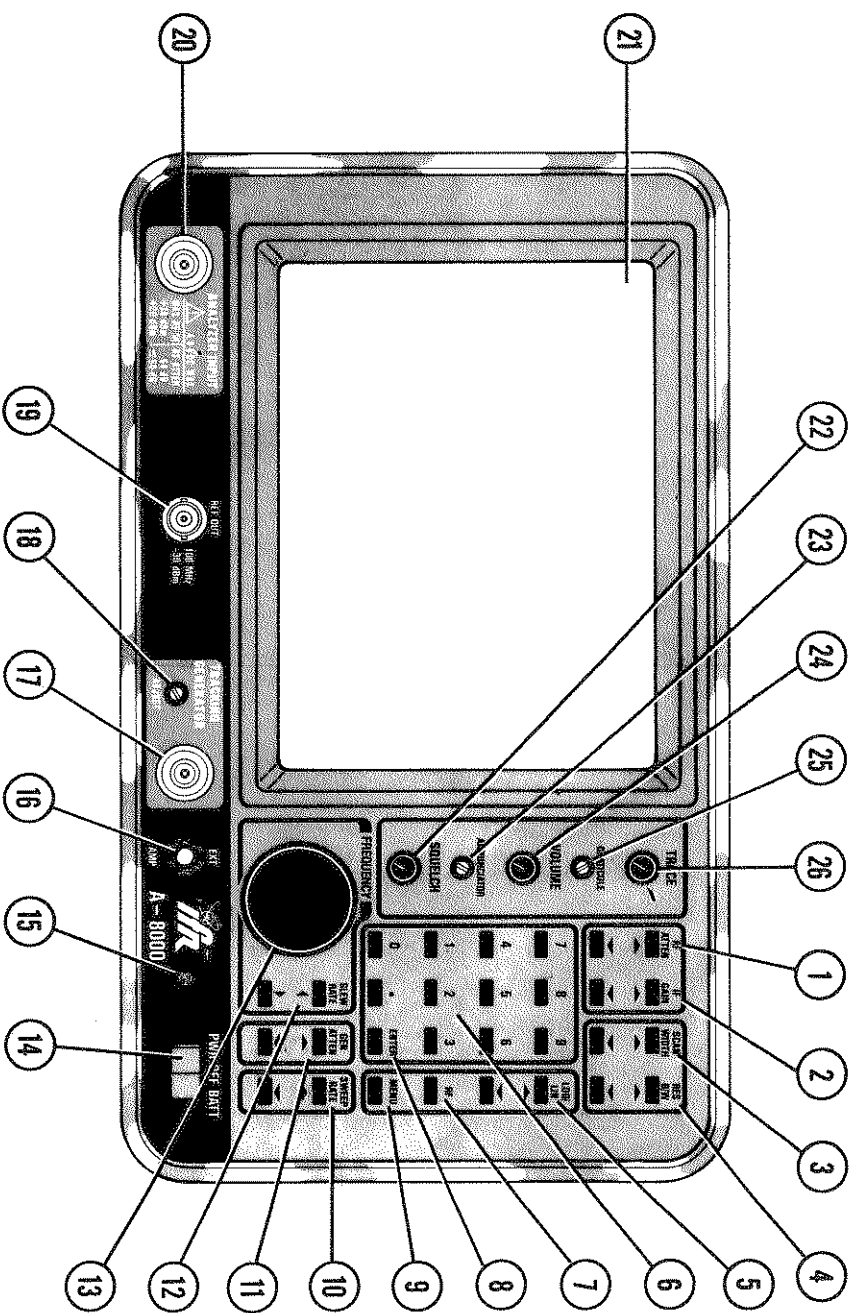

- | | |
|-------------------------|--|
| 1. RF ATTEN Keys | 15. Power On Indicator |
| 2. IF GAIN Keys | 16. EXT AMP Connector |
| 3. SCAN WIDTH Keys | 17. TRACKING GENERATOR Connector |
| 4. RES B/W Keys | 18. TRACKING ADJUST Control |
| 5. LOG/LIN Keys | 19. REF OUT Connector |
| 6. Numeric Keyboard | 20. ANALYZER INPUT Connector |
| 7. RF Key | 21. CRT Display |
| 8. ENTER Key | 22. SQUELCH Control |
| 9. MENU Key | 23. ANNUNCIATOR Volume Adjust Control |
| 10. SWEEP RATE Keys | 24. VOLUME Control |
| 11. GEN ATTEN Keys | 25. GRATICULE Intensity Adjust Control |
| 12. SLEW RATE Keys | 26. TRACE Intensity Control |
| 13. FREQUENCY Control | |
| 14. PMR/OFF/BATT Switch | |

Figure 3-1 A-8000 Front Panel Controls, Connectors and Indicators

ITEM	NAME	DESCRIPTION
------	------	-------------

- | | | |
|----|-------------------------------------|---|
| 1. | Keyboard keys and controls thru 13. | See Paragraph 3-4 for descriptions of all keyboard keys and controls. |
|----|-------------------------------------|---|

NOTE

The Frequency Control is not a key; but as it performs a keyboard related function, it is described as one.

- | | | |
|-----|---------------------|--|
| 14. | PMR/OFF/BATT Switch | |
|-----|---------------------|--|

Applies or interrupts electrical power as follows:

- PMR Position - A-8000 is powered by AC or DC power source.
- OFF Position - A-8000 is turned OFF.

BATT Position - A-8000 is powered by internal battery, if installed. Push once to apply battery power; push again to terminate battery operation. Plug into AC outlet to charge (see NOTE). The "BATT" position of the switch is spring loaded to the "OFF" position.

NOTE

A full charge requires at least 12 hours with a minimum external input of 15 VDC or 110 VAC.

- | | | |
|-----|------------------------------|---|
| 15. | Power On Indicator | Indicates A-8000 is turned on. |
| 16. | EXT AMP Connector | Provides power for optional External Amplifier. |
| 17. | TRACKING GENERATOR Connector | This is a Type-N Connector used for Tracking Generator Output. Impedance is normally 50Ω. |
| 18. | TRACKING ADJUST Control | Adjusts Tracking Generator frequency to match the Analyzer. |

ITEM	NAME	DESCRIPTION
19.	<u>REF OUT Connector</u>	Provides a 100 MHz signal at -30 dBm.
20.	<u>ANALYZER INPUT Connector</u>	Input Connector for A-8000. Input impedance is normally 50Ω.
21.	<u>CRT Display</u>	Spectrum Analyzer display for A-8000. Refer to Paragraph 3-3 for details.
22.	<u>SQUELCH Control</u>	Controls 10.7 MHz Receiver squelch threshold. Squelch disables demod audio output when RF input at ANALYZER INPUT Connector falls below squelch threshold. This control operates only when the 10.7 MHz Receiver is installed.
23.	<u>ANNUNCIATOR Volume Adjust Control</u>	Controls volume of tone heard when a key is pressed. Adjust for comfortable listening level.
NOTE		
24.	<u>VOLUME Control</u>	As the annunciator tone is one of the indications of an "accepted" key entry, it is not advisable to turn the annunciator volume completely off.
25.	<u>Graticule Intensity Control</u>	Controls audio level to A-8000 speaker. This control operates only when the 10.7 MHz Receiver is installed.
26.	<u>TRACE Intensity Adjust Control</u>	Adjusts brightness of displayed graticules. Adjust for desired contrast between displayed signals (trace) and graticules. Controls brightness of displayed signal field labels and menu.

Refer to Figure 3-2 to locate the following on the Rear Panel of the A-8000.

Figure 3-2 A-8000 Rear Panel

- 27. DC Fuse
- 28. DC Power Input Connector
- 29. AC Power Input Connector
- 30. AC Line Fuse
- 31. 10 MHZ External Reference
- 32. TCXO ADJ Connector
- 33. PEN LIFT Connector
- 34. Sweep Connector
- 35. Video Connector
- 36. Not used
- 37. GPIB or RS-232 Connector (Option)

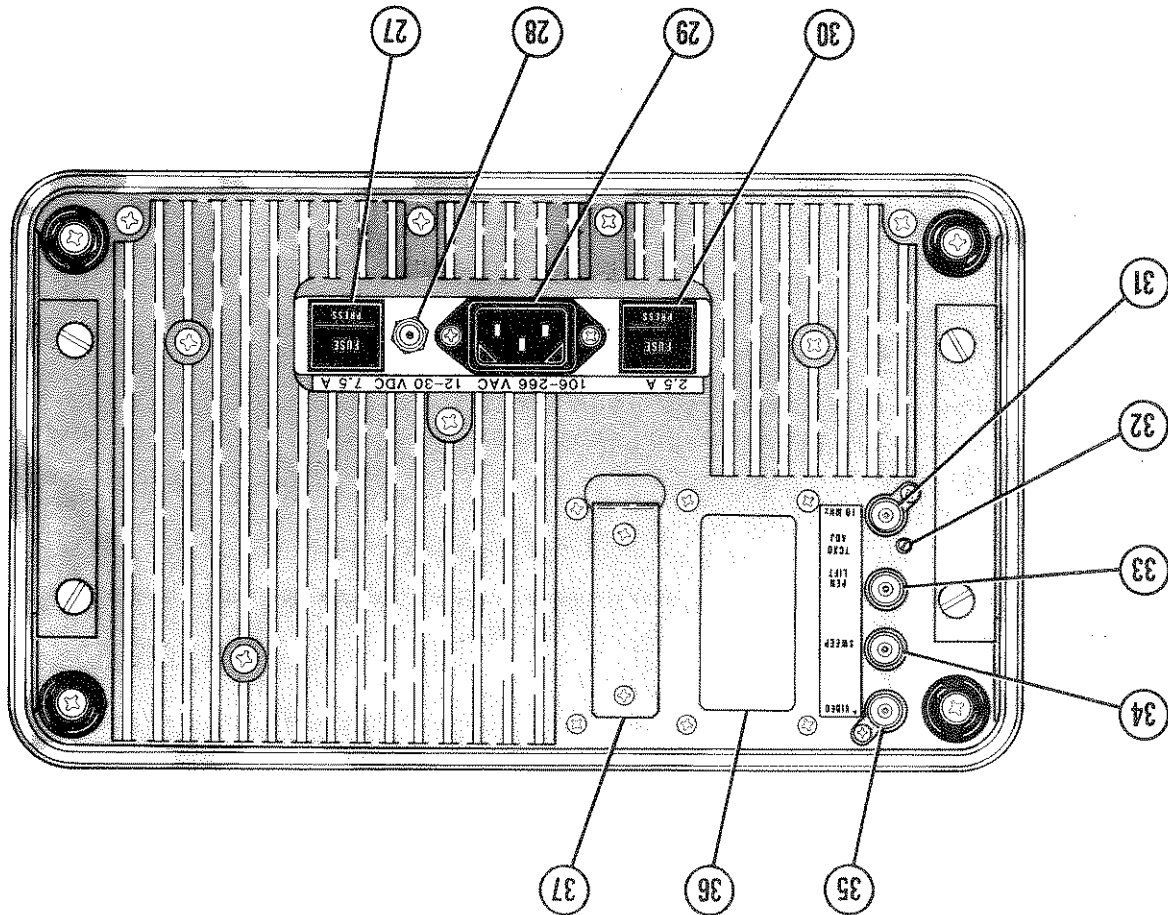

THIS PORT IS HIGH IMPEDANCE (0 TO 5V RAMP OUTPUT, NOMINAL, INTO 1 MΩ). ANY DEVICE CONNECTED TO IT MUST HAVE A HIGH IMPEDANCE INPUT TO PREVENT DAMAGE TO THE UNIT.

CAUTION

Provides an analog sweep output signal. May be connected to external equipment.

34. SWEEP Connector

Allows for Pen Lift and Scope Blanking commands to be sent to a plotter. Signal is 0 to 4 VDC TTL.

33. PEN LIFT Connector

Temperature of unit must be stabilized before adjusting the TCXO to ensure frequency accuracy.

NOTE

Provides an adjustment point for the internal 10 MHz reference frequency (Time Base).

32. TCXO Adjust

Allows monitoring of internal 10 MHz reference frequency or application of external 10 MHz reference frequency (Time Base) at +5 dBm to +20 dBm. The input and output are switched automatically.

31. 10 MHz External Reference Connector

2½ amp, 250 V

30. AC Line Fuse

Input connector for 106 to 266 VAC supply at 50 to 400 Hz.

29. AC Power Input Connector

12 to 30 VDC, nominal

28. DC Power Input Connector

7½ Amp, 32 VDC

27. DC Fuse

ITEM NAME DESCRIPTION

ITEM NAME DESCRIPTION

35. VIDEO Connector

Provides a real-time analog video signal before trace display is digitized. May be connected to external equipment.

CAUTION

THIS PORT IS HIGH IMPEDANCE (0 TO 800 mVDC OUTPUT, NOMINAL, INTO 1 MΩ). ANY DEVICE CONNECTED TO IT MUST HAVE A HIGH IMPEDANCE INPUT TO PREVENT DAMAGE TO THE UNIT.

36. Not used

37. GPIB or RS-232 Connector (option)

Allows communication between A-8000 microprocessor and GPIB or RS-232 Interface.

This displays the current value of the Center Frequency. The number of significant digits displayed is determined, in part, by the Scan Width selection. The Center Frequency value changes if the following keys are pressed: RF, ENTER (with or without selection of a Center Frequency value), or if the Frequency Control (13) is rotated. See Paragraphs 3-4-6, 3-4-7, 3-4-11 and 3-4-12.

3-3-1-2 CENTER FREQUENCY DISPLAY

3-3-1-3 BANDWIDTH DISPLAY

This block displays the current Resolution Bandwidth setting. It changes when one of the RES B/W keys is pressed (see Paragraph 3-4-4). It may also change if one of the SCAN WIDTH keys is pressed or the Center Frequency is changed when Bandwidth Optimization is active (See Appendix E).

NOTE

During Quasi-Peak operation, the Quasi-Peak function controls the Bandwidth block. Quasi-Peak bandwidths are assigned automatically at each Quasi-Peak operational selection.

3-3-1-4 MENU DISPLAY

This display shows the active menu. The area within the rectangular box (and including the box) is called the menu window. This appears only when the menu function is active. See Paragraph 4-1 for details.

3-3-1-5 SWEEP RATE DISPLAY

This displays the current Sweep Rate. It changes when one of the Sweep Rate keys is pressed up or down (see Paragraph 3-4-9). This display may also change when one of the SCAN WIDTH keys or one of the RES B/W keys is pressed. The SCAN WIDTH and RES B/W keys or selecting a Video Filter affect the Sweep Rate display only if Sweep Rate Optimization is active (see Appendix E).

3-3-1-6 RF ATTENUATION DISPLAY

This displays the current level of RF Attenuation. It changes when one of the RF ATTEN keys is pressed up or down, within the 0 to 60 dB range of the A-8000. See Paragraph 3-4-1.

3-3-1-7 TRACKING GENERATOR OUTPUT DISPLAY

This displays the RF level at the Tracking Generator output. If the Tracking Generator is not installed, this display is inhibited from the CRT. When the Tracking Generator is active, the output level is controlled by the GEN ATTEN keys (see Paragraph 3-4-10). When the Tracking Generator is installed, but the Generator option is turned off (GEN = 0 in SETUP Menu), the display that appears is "GEN -- unit". The unit is always the same as the unit displayed above the graticule scale.

The unit block may also display an error condition, if one is detected in the A-8000 Spectrum Analyzer. Paragraph 3-3-2 describes these conditions, and several other messages that are displayed on the A-8000.

Table 3-1 A-8000 Units Comparison

UNIT	TOP GRATICULE (0 dB RF ATTEN, 0 dB IF GAIN)	TOP GRATICULE (30 dB RF ATTEN, 0 dB IF GAIN)
50Ω OPERATION		
dBm	-30	0
dBmV	+17	+47
dBμV	+77	+107
dBV	-43	-13
dBmW	0	+30
75Ω OPERATION		
dBm	-24	+6
dBmV	+25	-5
dBμV	+85	+115
dBV	-35	-5
dBmW	+6	+36

This display shows the current calibration unit for the graticule scale labels. The unit can be changed in the SETUP Menu to display dBm, dBμW, dBV, dBmV or dBμV. Changing the units also changes the graticule readings as shown in Table 3-1. Table 3-1 shows the top graticule labels as different units are selected as they appear in the Menu. The RF Attenuation and IF Gain are kept constant. The difference between the readings in 50Ω operation and 75Ω operation are as they appear only if the impedance setting is changed.

3-3-1-9 GRATIUCLE UNIT DISPLAY

This shows the signal level and provides a numeric readout for the signal under observation. There are three settings for these labels: 10 dB increments/Division, 2 dB increments/Division and a Linear scale. The 10 dB/DIV and 2 dB/DIV scales provide a direct readout of the signal. The top graticule of the Linear scale shows the signal level with RF Attenuation and IF gain. Computing the Signal Amplitude on the Linear Scale is discussed in Appendix C. Graticule scales are changed with the RF ATTEN keys, LOG/LIN keys and in the SETUP Menu. See Paragraphs 3-4-1, 3-4-2, 3-4-5 and 4-7. The peak signal indicated by the graticule level is the ACTUAL Analyzer Input level of RF.

3-3-1-8 GRATIUCLES/DB SCALE LABELS

3-3-2 SPECIAL DISPLAY MESSAGES AND INDICATORS

3-3-2-1 UNCAL MESSAGE

This message is displayed where the Graticule Unit normally appears. It indicates the A-8000 is not at an optimal setting (see Appendix E).

3-3-2-2 UNLCK MESSAGE

This message is displayed where the Graticule Unit normally appears. It indicates an improperly functioning frequency synthesizer, which requires calibration or some other maintenance.

3-3-2-3 AC INDICATOR (Ac)

This indicator is displayed if the Auto Cal feature is turned off. It is set in the MANUAL Menu (see Paragraph 4-9) and appears between the SCAN WIDTH and CENTER FREQUENCY displays on the top of the screen.

3-3-2-4 MANUAL BANDWIDTH INDICATOR (M+)

This indicator (M+) is displayed in the upper right-hand corner of the screen. The arrow points to the Bandwidth display. It indicates Bandwidth Optimization is inactive (see Appendix E). This indicator appears only if "Bw" in the MANUAL Menu is set to "M" (see Paragraph 4-9).

3-3-2-5 MANUAL SWEEP RATE INDICATOR (M+)

This indicator (M+) is displayed in the lower right-hand corner of the screen. The arrow points to the Sweep Rate display. It indicates Sweep Rate Optimization is inactive (see Appendix E). This indicator appears only if "Swp" in the MANUAL Menu is set to "M" (see Paragraph 4-9).

3-3-2-6 FULL SCAN INDICATOR (FULL)

This indicator is displayed when the "RF, ENTER" keys are pressed, and no Center Frequency value is selected. It indicates maximum Scan Width selection for the A-8000 Spectrum Analyzer (265 MHz/DIV). The Center Frequency is assigned a value of 1275.0 MHz. "FULL" appears instead of the Scan Width display and is replaced with a numeric value when the Scan Width or the Center Frequency changes.

3-3-2-7 VIDEO FILTER INDICATOR (VF 30K or VF 300)

The Video Filter Indicator is displayed only when one of the Video Filters (30 KHz or 300 Hz) is active. It appears in the upper-left quadrant of the CRT display. The indicator is set in the FILTERS Menu (see Paragraph 4-6).

3-4 KEYBOARD

Refer to Figure 3-3 to locate CRT displays and to Table 3-2 as a reference for entering key values. All keys on the A-8000 Spectrum Analyzer, except RF, ENTER, MENU and Numeric keys, are paired (up and down or left and right) for operator convenience.

Normally, when pressing a key on the keyboard, a tone is heard if an applicable change is made on the CRT display. However, on several of these keys (RF ATTEN, IF GAIN, SWEEP RATE and GEN ATTEN) the micro-processor disables the tone and inhibits the entry when attempting to enter an invalid value. If this happens, the operator may enter a valid setting.

When selecting a Center Frequency, if four digits are pressed after the decimal, the Center Frequency is entered automatically. Thus, it is not necessary to press the ENTER key in this situation. However, if less than four digits are entered after a decimal, the ENTER key must be pressed for the Center Frequency to be accepted.

KEY(S)	USE	ENTRY METHOD
RF ATTEN	RF input atten from 0 to 60 dB in 10 db steps	RF ATTEN up or RF ATTEN down
IF GAIN	Internal IF gain from 0 to 65 dB in 1 db steps	IF GAIN up or IF GAIN down
SCAN WIDTH	Analyzer Display Scan Width from 1 kHz/DIV to 250 MHz/DIV; 0 for fixed-tuned receiver	SCAN WIDTH up or SCAN WIDTH down
SWEEP RATE	Analyzer Display sweep rate from 5 msec/DIV to 10 SEC/DIV	SWEEP RATE up or SWEEP RATE down
RES B/W	Analyzer Bandwidth - 300 Hz, 3 kHz, 30 kHz, 300 kHz or 3 MHz	RES B/W up or RES B/W down
LOG/LIN	Log - 10 db or 2 db per division on vertical scale Lin - selects Linear display mode	Press LOG/LIN up or LOG/LIN down
RF	Enter center frequency setting	RF XXXX.XXXX ENTER* or RF, ENTER
MENU	Initiate/Terminate Menu display	Press MENU
SLEW RATE	Center frequency digital slew setting	Press LEFT or RIGHT to increase or decrease significant digit being slewed.
FREQUENCY CONTROL	Slows Center Frequency	Increases (CW) or Decreases (CCW) Center Frequency.
GEN ATTEN	RF output atten from 0 to -70 dbm in 1 db steps	GEN ATTEN up or GEN ATTEN down
NUMBERS	Center frequency entry and menu ops	Redefined by RF and MENU keys
ENTER	Direct center frequency entry. Returns FULL SCAN display to previous display selections.	RF XXXX.XXXX ENTER*; RF, ENTER or ENTER (after RF, ENTER only).

*Values entered for RF entries can contain one to eight digits. The maximum length on either side of the decimal point is shown here. The decimal is optional for integer values 0-2500 (2500 is the maximum acceptable RF entry). Entering an invalid value suppresses the beep tone. When entering less than four digits after the decimal point, the ENTER key must be pressed.

Table 3-2 A-8000 Keyboard Quick Reference

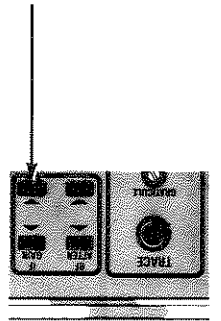

FUNCTION: Set the internal IF gain level.
 RANGE: 0 to 65 dB in 1 db steps.
 USE: IF GAIN UP (↑) causes IF GAIN to increase. IF GAIN DOWN (↓) causes IF GAIN to decrease. The signal level is read directly from the CRT display, regardless of the IF GAIN and RF ATTEN settings.

3-4-2 IF GAIN KEYS (2)

FUNCTION: Set the internal IF gain level.
 RANGE: 0 to 65 dB in 1 db steps.
 USE: IF GAIN UP (↑) causes IF GAIN to increase. IF GAIN DOWN (↓) causes IF GAIN to decrease. The signal level is read directly from the CRT display, regardless of the IF GAIN and RF ATTEN settings.

NOTE

If a key is pressed and no beep is heard and (or) the display blocks do not change, then you have reached the end of the range of values. Check the range of values before selecting another entry.

NOTE

The graticule readings are automatically changed if the Reference Scale Unit is changed (see Table 3-1).

Table 3-3 Interaction of RF ATTEN and IF GAIN

RF ATTEN	IF GAIN	Top Graticule Reading
0	0	-30
10-60	0	-20 to +30
0	1-65	-31 to -95
10-60	1-65	+29 to -85

FUNCTION: Set the attenuation of the RF signal input.
 RANGE: 0 to 60 dB, in 10 db steps.
 USE: RF ATTEN UP (↑) causes attenuation to increase. RF ATTEN DOWN (↓) causes attenuation to decrease. Using RF ATTEN with IF GAIN sets the top graticule of the CRT display as shown in Table 3-3. Generally, the RF ATTEN keys are used when the input signal level is greater than -30 dbm.

3-4-1 RF ATTEN KEYS (1)

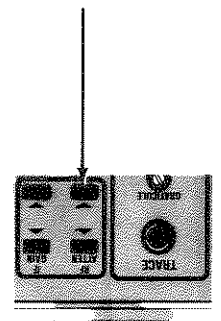

FUNCTION: Set the attenuation of the RF signal input.
 RANGE: 0 to 60 dB, in 10 db steps.
 USE: RF ATTEN UP (↑) causes attenuation to increase. RF ATTEN DOWN (↓) causes attenuation to decrease. Using RF ATTEN with IF GAIN sets the top graticule of the CRT display as shown in Table 3-3. Generally, the RF ATTEN keys are used when the input signal level is greater than -30 dbm.

FUNCTION: Set the internal IF gain level.
 RANGE: 0 to 65 dB in 1 db steps.
 USE: IF GAIN UP (↑) causes IF GAIN to increase. IF GAIN DOWN (↓) causes IF GAIN to decrease. The signal level is read directly from the CRT display, regardless of the IF GAIN and RF ATTEN settings.

NOTE

If a key is pressed and no beep is heard and (or) the display blocks do not change, then you have reached the end of the range of values. Check the range of values before selecting another entry.

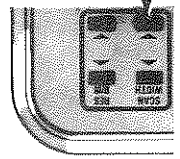

FUNCTION: Set analyzer display Scan Width.
 RANGE: 0, 1, 2, 5, 10, 20, 50, 100, 200 or 500 KHZ/DIV;
 USE: 1, 2, 5, 10, 20, 50, 100, 200 or 250 MHZ/DIV.

SCAN WIDTH UP (↑) causes the Scan Width to increase until the maximum allowable Scan Width setting for the Center Frequency setting is reached (see Table 3-4). If the SCAN WIDTH UP (↑) key is pressed after the maximum allowable Scan Width value is displayed, the list cycles to the lowest Scan Width value (0 Scan). The values then increase until the desired value appears in the Scan Width display (see Figure 3-3).

SCAN WIDTH DOWN (↓) causes the Scan Width to decrease until the 0 Scan Width setting is reached. If the SCAN WIDTH DOWN key is pressed after the 0 Scan Width value is displayed, the Scan Width cycles to the maximum allowable Scan Width setting for the Center Frequency (CF) selection (see Table 3-4). The value then decreases until the desired value appears in the Scan Width display (see Figure 3-3).

Zero is selected for fixed-tune receiver operation. When selecting a Scan Width, the Resolution Bandwidth and Sweep Rate may change. This is the result of optimization; which is discussed in Appendix E. Also, the number of significant digits used for the Center Frequency may vary as the Scan Width increases or decreases.

MAXIMUM SCAN WIDTH SETTING (MHZ/DIV)	CENTER FREQUENCY RANGE (MHZ)
10	0.0 - 49.9999
20	50.0 - 199.9999
50	200.0 - 449.9999
100	450.0 - 949.9999
200	950.0 - 1199.9999
250	1200.0 - 1750.0
200	1750.0001 - 2000.0
100	2000.0001 - 2500.0

Table 3-4 Maximum Selectable Scan Widths at Allowable A-8000 CF Settings

For any Center Frequency selected, the microprocessor inhibits Scan Width settings which would display a signal less than -50 MHZ or greater than +3000 MHZ. For example, if the Scan Width is set at 100 MHZ/DIV and the Center Frequency is set at 100.0 MHZ, SCAN WIDTH will be reset to 20 MHZ/DIV.

3-4-4 RES B/W KEYS (4)

FUNCTION: Manually set bandwidth of analyzer trace (bandwidth can be automatically set by the microprocessor, but the RES B/W keys override the automatic selection). A detailed explanation of Resolution Bandwidth functions is the subject of Appendix D of this manual.

RANGE: 300 Hz, 3 KHz, 30 KHz, 300 KHz or 3 MHz.

USE: Resolution Bandwidth can be automatically or manually selected for each bandwidth (see Appendix E and Paragraph 4-9). The UP key (↑) changes the bandwidth selection in increasing order, the DOWN key (↓) changes the bandwidth selection in decreasing order. If the Sweep Rate and Scan Width are too fast for the selected Resolution Bandwidth, "UNCAL" is displayed on the CRT instead of the graticule unit (see Figure 3-3).

NOTE

See Appendix D for a description of the Resolution Bandwidth function.

3-4-5 LOG/LIN KEYS (5)

FUNCTION: Set the vertical scale of analyzer graticule display. 2 dB increments, 10 dB increments or, using the LIN scale, 18 dB for the top 87.5 percent of the screen (see Paragraph 8-2-2 and Appendix C for details on Linear Scale).

RANGE: Top graticule axis is set by selecting RF ATTEN and IF GAIN settings per Table 3-3. Intermediate horizontal graticules are not labeled in LINEAR mode. The UP (↑) key cycles the vertical scale from 2 dB/DIV to 10 dB/DIV to LINEAR mode; the DOWN (↓) key cycles the vertical scale from LINEAR mode to 10 dB/DIV to 2 dB/DIV.

USE: 10 dB and 2 dB sets all horizontal graticules in 10 dB or 2 dB increments. The top graticule corresponds with the RF ATTEN and IF GAIN settings per Table 3-3.

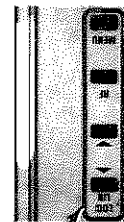

FUNCTION: Set the vertical scale of analyzer graticule display. 2 dB increments, 10 dB increments or, using the LIN scale, 18 dB for the top 87.5 percent of the screen (see Paragraph 8-2-2 and Appendix C for details on Linear Scale).

RANGE: Top graticule axis is set by selecting RF ATTEN and IF GAIN settings per Table 3-3. Intermediate horizontal graticules are not labeled in LINEAR mode. The UP (↑) key cycles the vertical scale from 2 dB/DIV to 10 dB/DIV to LINEAR mode; the DOWN (↓) key cycles the vertical scale from LINEAR mode to 10 dB/DIV to 2 dB/DIV.

USE: 10 dB and 2 dB sets all horizontal graticules in 10 dB or 2 dB increments. The top graticule corresponds with the RF ATTEN and IF GAIN settings per Table 3-3.

If a key is pressed and no beep is heard and (or) the display blocks do not change, then the entry is invalid. Check the range of values before selecting another entry.

NOTE

When "RF ENTER" is entered, the message "FULL" is displayed in the SCAN WIDTH block, designating maximum Scan Width selection. This display remains until the Scan Width or the Center Frequency changes. When in FULL SCAN, the previous display and its parameters can be reset by pressing "ENTER". This feature operates in FULL SCAN only.

NOTE

To automatically set the Center Frequency to 1275.0 MHz and the Scan Width to 265 MHz/DIV, press the following keys:

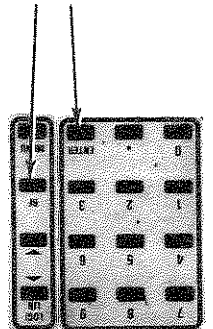

Where nnnn.nnn is the value of the Center Frequency from 0 to 2500.0. If four digits are entered after the decimal, the Center Frequency is entered automatically.

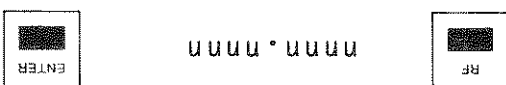

Select and enter a Center Frequency entry. Entry of Center Frequency is made using two selection methods: manual and automatic. To manually select a CF, press the key sequence:

3-4-7 RF/ENTER KEYS (7/8)

NOTE

Enter direct Center Frequency values or make menu selections. These functions are defined by the RF and MENU keys. When used with the RF key, the numeric keys (and the decimal point) are used to select the Center Frequency. The range of valid entries is from 0 to 2500.0000 (MHz). When used during Menu operation the numeric keys are used to select menus and operating parameters, as described in Section 4.

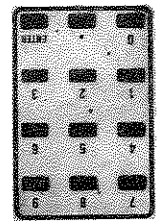

3-4-6 NUMERIC KEYS (6)

If a key is pressed and no beep is heard and (or) the display blocks do not change, then you have reached the end of the range of values. Check the range of values before selecting another entry.

NOTE

Set Sweep Rate of analyzer display. RANGE: 5, 10, 20, 50, 100, 200, 500, msec/DIV; 1, 2, 5 and 10 Sec/DIV. USE: SWEEP RATE UP (↑) causes sweep rate to increase (sweep time decreases). SWEEP RATE DOWN (↓) causes sweep rate to decrease. Sweep Rates can be automatically selected via the Scan Width and RES B/W Keys or by selecting a video filter, but may be set independently to one of the sweep rates shown above (see Paragraph 4-9 and Appendix E). If the Sweep Rate selected for the Scan Width and Resolution Bandwidth is too fast, "UNCAL" is displayed on the CRT instead of the graticule unit (see Figure 3-3).

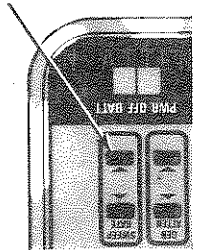

3-4-9 SWEEP RATE KEYS (10)

Turns menu display on or off. FUNCTION: Pressing "MENU" causes the Master Menu to appear on the CRT. Pressing MENU a second time, clears any Menu display. Pressing MENU twice in succession when any other menu is displayed, causes the Master Menu to appear on the CRT (see Paragraph 4-1).

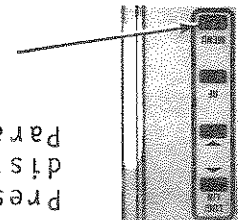

3-4-8 MENU KEY (9)

When using the Slew Rate keys (left or right), the cursor disappears when it is moved left of the 1 GHz digit or right of the 100 Hz digit.

These keys do not change the Center Frequency; This is the function of the Frequency Control (see Paragraph 3-4-12).

NOTE

Select the digit of the Center Frequency being slewed (see Figure 3-4).
 RANGE: 100 Hz digit to 1 GHz digit in increments of powers of 10.
 USE: Pressing either SLEW RATE key (RIGHT or LEFT) changes the Slew Rate by powers of 10. The Center Frequency digit to be slewed is displayed in reverse video as a non-blinking cursor. When either Slew Rate key is pressed, the digit where the cursor appears is relative to the current Scan Width selection. Pressing SLEW RATE LEFT (←) moves the cursor left, which results in changing the Slew Rate at larger increments. Pressing SLEW RATE RIGHT (→) moves the cursor right, which results in changing the Slew rate at smaller increments.



3-4-11 SLEW RATE KEYS (12)

If a key is pressed and no beep is heard and (or) the display blocks do not change, then you have reached the end of the range of values. Check the range of values before selecting another entry.

NOTE

FUNCTION: Set the output level if the Tracking Generator is installed and enabled.
 RANGE: 0 to -70 dBm in 1 db steps.
 USE: GEN ATEN UP (↑) causes output level to increase, GEN ATEN DOWN (↓) causes output level to decrease.

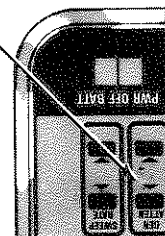

3-4-10 GEN ATEN KEYS (11)

Figure 3-5 Center Frequency Display With Slew Rate Cursor Illuminated

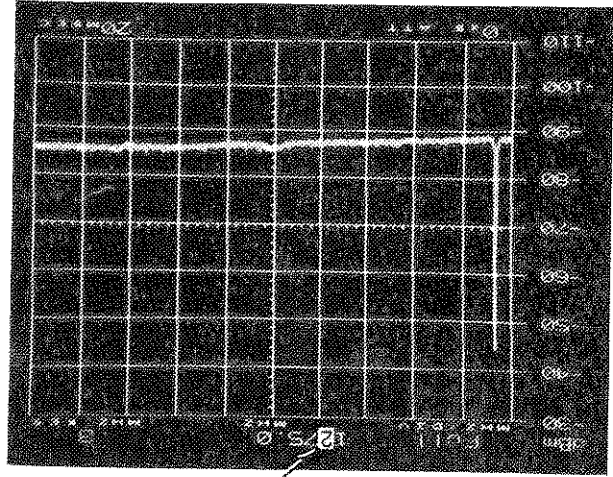

SLEWED DIGIT

When changing the Center Frequency, the Scan Width may change (see Table 3-4 for maximum allowable Center Frequency settings).

NOTE

FUNCTION: Increases or Decreases Center Frequency (CF).
 RANGE: 0 to 2500 MHZ.
 USE: The Frequency Control (I3) changes the CF at the selected slew rate setting (see Figure 3-4). If the slew rate cursor is not illuminated in the CF display, the Frequency Control changes the CF proportional to the Scan Width (i.e., Scan Width X .1).

3-4-12 FREQUENCY CONTROL (I3)

Figure 3-4 Frequency Slew Digit Selection

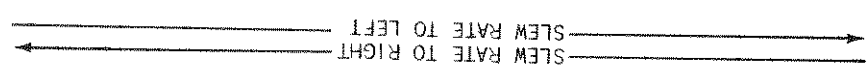

RATE OF CHANGE FROM CF (X MHZ) 10^3 10^2 10^1 10^0 10^{-1} 10^{-2} 10^{-3} 10^{-4}

1234.5678

CENTER FREQUENCY DISPLAY (MHZ)

A-8000 operating parameters are set using direct entries from the keyboard: as described in Section 3 or via menu operation. Enter menu operation by pressing "MENU" on the keyboard. Menus can be subsequently cleared from the CRT display by pressing "MENU" a second time or by pressing "Ø" on the keyboard when the "Master" menu is displayed in the menu "window" (i.e., the area of the CRT display where the menu appears).

4-1-1 MENU LEVELS

A-8000 menus operate on multiple levels (see Figure 4-1). The Master Menu is the only first level menu. It is used to select a second level menu. The selections are listed in the menu window (DISP, MODE, RCVR, FILTERS, SETUP and, optionally, PLOT/PRINT). Select a second level menu by pressing the NUMBERED KEY corresponding with the number listed in the menu window left of the desired menu.

Two second level menus can be used to select third level menus. The FILTERS menu can be used to select the QUASI-PEAK menu. The SETUP menu can be used to select the REMOTE, MANUAL and TEST menus. Also, some menus can be selected only if a particular option is installed (QUASI-PEAK, RCVR or REMOTE). If one of these menus is selected and the option is not installed, the OPTION NOT INSTALLED menu appears in the menu window.

NOTE

The REMOTE menu displays either the RS-232 menu or the GPIB menu, when selected, if either option is installed.

Return to the previous menu level by pressing 0 (RETURN) on the keyboard. Pressing the MENU Key twice in succession during menu operation causes the Master Menu to appear in the menu window.

1. The figures in this section are to illustrate the various A-8000 MENUS. Parameter values and waveforms should be ignored in every instance -- unless specifically referred to in the text.
2. The key shown next to each paragraph is that key required to select the corresponding function in the menu.

4-2 MASTER MENU

To enter menu operation, press the MENU key once. All other menus on the A-8000 are directly or indirectly selected from the Master Menu.

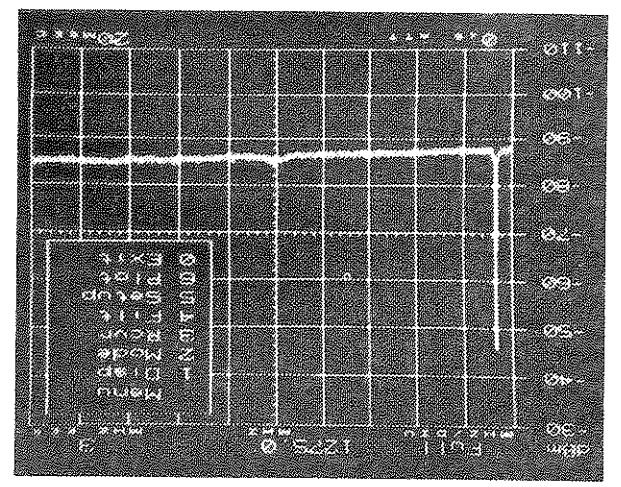

a) Master Menu with GPB

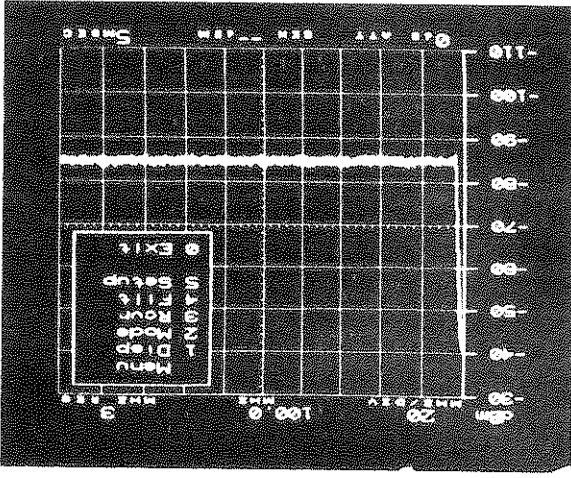

b) Master Menu without GPB

Figure 4-2 Master Menus

- 1 To select the CRT Display (DISP) Menu, press "1" on the keyboard. The DISP Menu is discussed in Paragraph 4-3. To return to the Master Menu, press "0" on the keyboard.
- 2 To select the Signal Display (MODE) Menu, press "2" on the keyboard. The MODE Menu is discussed in Paragraph 4-4. To return to the Master Menu, press "0" on the keyboard.
- 3 To select the Receiver Bandwidth (RCVR) Menu, press "3" on the keyboard. The RCVR Menu is discussed in Paragraph 4-5. If the 10.7 MHz Receiver is not installed in the A-8000, refer to Paragraph 4-12. To return to the Master Menu, press "0" on the keyboard.
- 4 To select the Video and Quasi-Peak FILTERS Menu, press "4" on the keyboard. The FILTERS Menu is discussed in Paragraph 4-6. To return to the Master Menu, press "0" on the keyboard.

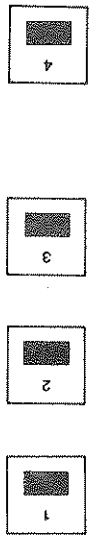

To select the SETUP Menu, press "5" on the keyboard. The SETUP Menu is discussed in Paragraph 4-7. To return to the Master Menu, press "0" on the keyboard.



Refer to Paragraph 4-11 before selecting the PLOT/PRINT function. If the GPB option is not installed in the A-8000 and this function is selected, the menu display is inhibited. To return to the Master menu, press "0".



4-3 DISPLAY (DISP) MENU

To select the Display (DISP) Menu, press "1" on the keyboard when the Master Menu appears in the menu window. To select a display function, the DISP Menu must appear in the menu window. The arrow in the menu window points to the current menu selection (e.g., "REF" in Figure 4-3).

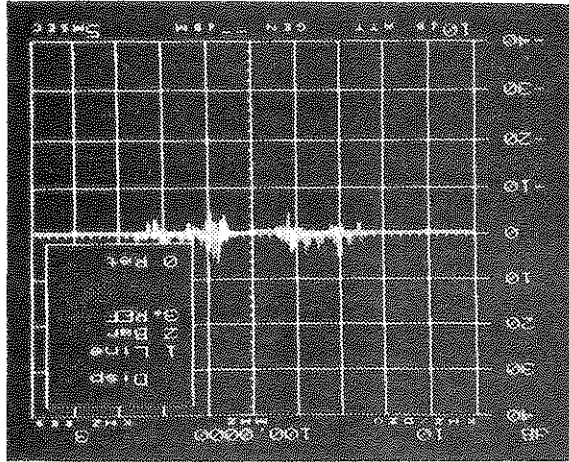

Figure 4-3 DISPLAY (DISP) Menu

To select LINE display, press "1" on the keyboard. This causes the Analyzer Trace to be represented as a solid line.



To select BAR display, press "2" on the keyboard. This causes the Analyzer Trace to be represented as a shaded area on the CRT.



To select REF display, press "3" on the keyboard. The REF display shows a signal display which represents the difference between a live trace and a stored trace. (Live and stored traces are discussed in Paragraph 4-4).



To select AVE (Average) mode, press "1" on the keyboard. In this mode, the last three sweeps are averaged with the current sweep (i.e., four sweeps), which are continuously updated to reflect the average.

To select COMP (Compare) Mode, press "2" on the keyboard. The trace stored in memory is compared to and displayed with the current (live) trace. The shaded area is the difference between the live and stored traces. Selecting COMP automatically sets the DISPLAY Menu to BAR.



Figure 4-4 MODE Menu

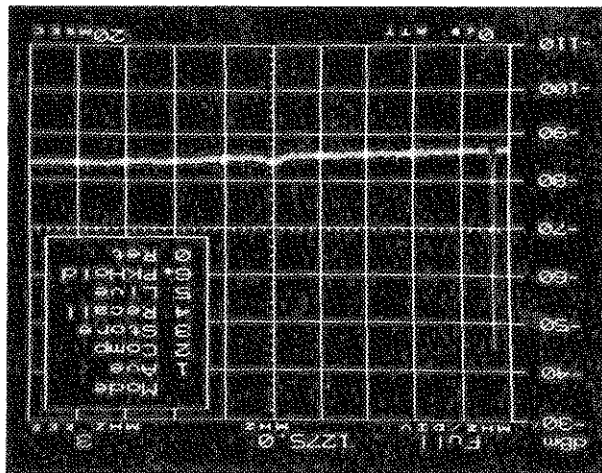

To select the MODE Menu, press "2" on the keyboard when the Master Menu appears in the menu window. The MODE Menu must appear in the menu window before selecting a mode for signal display. The arrow in the menu window points to the current menu selection (e.g., "PKHOLD" in figure 4-4).

4-4 MODE MENU

returning to the Master Menu.

To return to the Master Menu, press "0" on the keyboard.



Select LINE display mode (Press  before)

NOTE

When REF mode is selected, the entire display changes to display 0 db as a reference at the center graticule (see Figure 4-3). Returning to LINE or BAR display mode returns the scale and unit to their previous settings.

NOTE

To select STORE Mode, press "3" on the keyboard. The current trace and display parameters are stored.



NOTE

When store is selected, the arrow in the menu window momentarily points to "3" and returns to the previous selection.

To select RECALL Mode, press "4" on the keyboard. The stored trace, with its parameters, are recalled and displayed on the CRT. Changing any parameter after selecting RECALL results in the A-8000 switching to LIVE Mode.



NOTE

Changing menu parameters when RECALL Mode is active may result in erroneous, even conflicting, CRT displays. Do not change menu parameters in RECALL Mode.

To select LIVE Mode, press "5" on the keyboard. This is the normal mode of operation.



To select PKHOLD (Peak Hold) Mode, press "6" on the keyboard. PKHOLD Mode continually stores and displays maximum signal amplitude. The difference between the current signal and the maximum signal is displayed as a shaded area.



NOTE

Select LIVE mode (press ) before returning

to the Master Menu.

To return to the Master Menu, press "0" on the keyboard.



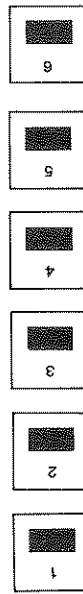

To select the FMI (15 kHz narrow band) Receiver Bandwidth, press "1" on the keyboard.

To select the FM2 (200 kHz wide band) Receiver Bandwidth, press "2" on the keyboard.

To select the SSB (6 kHz Single Side Band) Receiver Bandwidth, press "3" on the keyboard.

To select the AM1 (6 kHz narrow band) Receiver Bandwidth, press "4" on the keyboard.

To select the AM2 (15 kHz wide band) Receiver Bandwidth, press "5" on the keyboard.

To select Time Share Reception ON (TSR = 1) or OFF (TSR = 0), press "6" on the keyboard. When TSR is on, the A-8000 sweeps the frequency spectrum for ONE FULL SWEEP; it then locks into Center Frequency for ONE FULL SECOND, to allow audio to be heard. The controller is then updated and another full sweep is taken, repeating the cycle. If TSR is inactive, zero scan width must be selected for fixed-tune operation. (See NOTE on next page.)

Figure 4-5 RCVR Menu

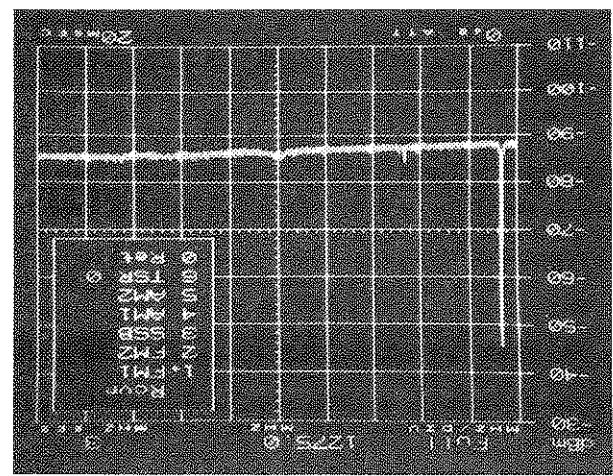

To select the RCVR (Receiver) Menu, press "3" on the keyboard when the Master Menu appears in the menu window. The RCVR Menu only appears if the 10.7 MHz Receiver is installed in the A-8000. Otherwise, the OPTION NOT INSTALLED menu (see Paragraph 4-12) appears in the menu window when this menu is selected. The RCVR Menu must appear in the menu window before selecting a receiver option. The arrow in the menu window points to the current menu selection, (e.g., "FMI" in figure 4-5 except the TSR selection).

4-5 RCVR MENU

If a video filter is selected, the selected filter value (30 KHz or 300 Hz) is displayed in the upper-left quadrant of the CRT screen (see Figure 4-6). If the filter display is on the screen, then the video filter is active.

4-6-1 VIDEO FILTER INDICATOR

Figure 4-6 FILTERS Menu

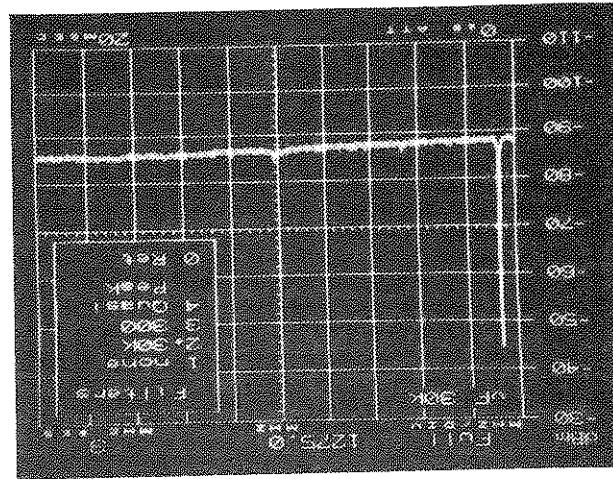

To select the FILTERS Menu, press "4" on the keyboard when the Master Menu appears in the menu window. The FILTERS Menu must appear in the menu window to select a filter. The arrow in the menu window points to the current menu selection (e.g., 30K in Figure 4-6).

4-6 FILTERS MENU



To return to the Master Menu, press "0" on the keyboard.

Set TSR to 0. Then select the receiver band-width you wish to use for operation before returning to the Master Menu.

NOTE

During TSR operation, the speaker sounds increasingly disrupted as the sweep time becomes slower. Also, CERTAIN KEYS MAY APPEAR TO HAVE AN ACTION DELAY AS KEY ENTRIES ATTEMPTED DURING AUDIO RECEPTION ARE IGNORED (i.e., they are locked out by the controller).

NOTE

Figure 4-7 QUASI-PEAK Menu

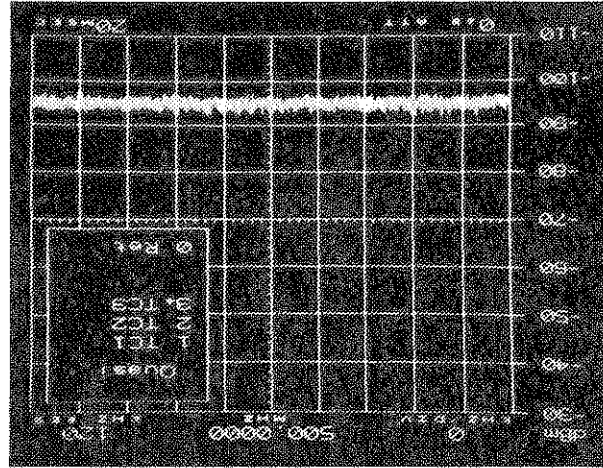

To select the QUASI-PEAK Menu, press "4" on the keyboard when the FILTERS Menu appears in the menu window. The Quasi-Peak Menu appears only if the Quasi-Peak Detector is installed in the A-8000. Otherwise, the OPTION NOT INSTALLED menu appears in the menu window. The Quasi-Peak Menu must appear in the menu window before selecting a Quasi-Peak function (see Section 8 for full operation details). The arrow in the menu window points to the current menu selection (e.g., "TC3" in Figure 4-7).

4-6-3 QUASI-PEAK FILTER MENU

To return to the Master Menu, press "0" on the keyboard.



returning to the Master Menu.

Select "NONE" (press ) for operation before

NOTE

To select the 30 KHz Video Filter, press "2" on the keyboard. Optimization may occur. Refer to Table E-4 for details.

To select the 300 Hz Video Filter, press "3" on the keyboard. When the 300 Hz Video Filter is selected, Sweep Rate Optimization may occur. Refer to Table E-3 for details.

The Quasi-Peak Menu, described in Paragraph 4-6-3, can only be selected when the Quasi-Peak option is installed.



To select NO FILTERING (NONE), press "1" on the keyboard.



4-6-2 FILTERS MENU SELECTIONS

NOTE

When Quasi-Peak is selected:

1. The microprocessor automatically sets the video filter to "NONE" (i.e., no video filter).
2. Optimization occurs to conform the Resolution Bandwidth and Sweep Rate to the Time Constant selection. These settings remain until another FILTERS Menu selection is made.
3. When the Quasi-Peak Detector is turned off (i.e., another filter or no filter is selected), the Resolution Bandwidth is automatically reset to the next highest setting. For example, if TCI is used during Quasi-Peak operation, when the Quasi-Peak Detector is turned off, the Resolution Bandwidth will be reset to 300 Hz.

To select TCI (Time Constant 1), press "1" on the keyboard when the Quasi-Peak Menu appears in the menu window. TCI provides the charge and discharge time required for Quasi-Peak measurements from 10 KHz to 150 KHz and sets the Resolution Bandwidth to 200 Hz.



To select TC2 (Time Constant 2), press "2" on the keyboard when the Quasi-Peak Menu appears in the menu window. TC2 provides the charge and discharge time required for Quasi-Peak measurements from 150 KHz to 30 MHz and sets the Resolution Bandwidth to 9 KHz.



To select TC3 (Time Constant 3), press "3" on the keyboard when the Quasi-Peak Menu appears in the menu window. TC3 provides the charge and discharge time required for Quasi-Peak measurements from 30 MHz to 1 GHz and sets the Resolution Bandwidth to 120 KHz.



To return to the FILTERS Menu, press "0" on the keyboard and select "NONE" (press ).



Changing the menu setting does not change the impedance! A 50 to 75Ω adapter must be connected to the ANALYZER INPUT Connector (20) to operate the A-8000 at 75Ω. Also, if using a Tracking Generator, a second 50 to 75Ω adapter must be connected to the Tracking Generator Connector (17), for 75Ω operation.

NOTE

Press "1" on the keyboard, to select 50Ω or 75Ω operation. The current impedance selection is displayed in the menu window (see Table 3-1). Set this parameter to 50Ω operation.



Figure 4-8 SETUP Menu

- (a) SETUP Menu Without Tracking Generator
- (b) SETUP Menu With Tracking Generator

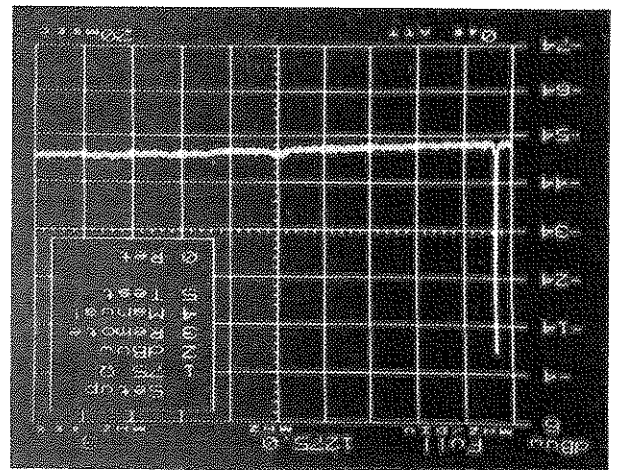
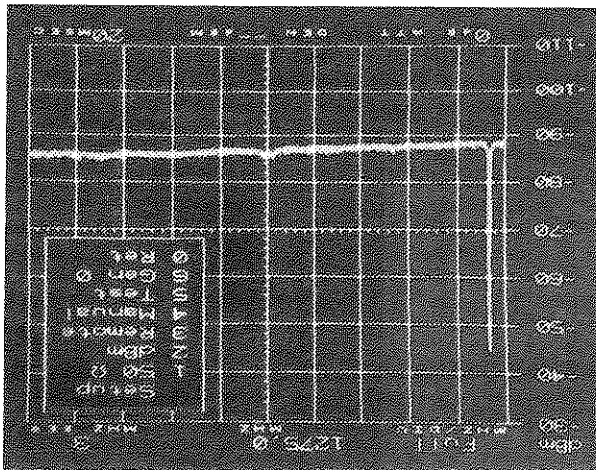

To select the SETUP Menu, press "5" on the keyboard when the Master Menu appears in the menu window. The SETUP Menu must appear in the menu window before selecting SETUP functions (see Figure 4-8).

To select the REMOTE Menu, press "3" on the keyboard when the SETUP Menu appears in the menu window. When REMOTE is selected, the menu appearing in the menu window depends on the option installed in the A-8000:

- The GPIB Menu appears when the GPIB option (Option 05) is installed (see Paragraph 4-8-1).
- The RS-232 Menu appears when the RS-232 option (Option 06) is installed (see Paragraph 4-8-2).
- The OPTION NOT INSTALLED Menu appears when neither the GPIB nor the RS-232 option is installed (see Paragraph 4-12).

4-8 REMOTE MENU

It is recommended to set the Tracking Generator OFF (GEN = 0), unless specific measurements are being made with it.

To return to the Master Menu, press "0" on the keyboard.



NOTE

To reset the graticule unit, press "2" on the keyboard. The following units are selectable on the A-8000: dbm, dBmV, dBuV, dBV or dBuW. The current setting is displayed in the menu window. See Table 3-1 for graticule label differences when changing the unit. Set this parameter to "dBm".

To select the REMOTE operating mode described in Paragraph 4-8, press "3" on the keyboard. If neither Remote Option is installed (i.e., GPIB or RS-232), the OPTION NOT INSTALLED Menu appears in the Menu Window (see Paragraph 4-12).

To select the MANUAL Menu described in Paragraph 4-9, press "4" on the keyboard.

To select the TEST Menu described in Paragraph 4-10, press "5" on the keyboard.

To set the Tracking Generator ON (Gen = 1) or OFF (Gen = 0), press "6" on the keyboard. The Tracking Generator must be installed in the A-8000 for this selection to appear in the SETUP Menu window (see Figures 4-8(a) and 4-8(b)). The unit in the Tracking Generator display corresponds with the unit in the Menu Window display (as set in Item 2).





To return to the SETUP Menu, press "0" on the keyboard.

The device selected is stored in non-volatile RAM. Therefore, unless changing the device, it is not required to change this menu selection each time the A-8000 is powered on.

NOTE

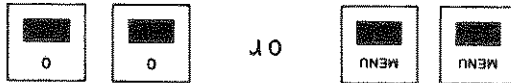

To select the print or plot device, press "2" on the keyboard. Select print if a Hewlett Packard Thinkjet™ printer is connected to the A-8000; select plot if a Hewlett Packard Graphics Language (HP-GL)™ compatible plotter is connected to the A-8000. Item 6 in the Master Menu will reflect this selection. To return to the Master Menu, press :



To select the GPIB Address, press "1" on the keyboard until the desired address appears in the menu window. The range of this address is from 00 to 31 (decimal values).



Figure 4-9 GPIB Menu

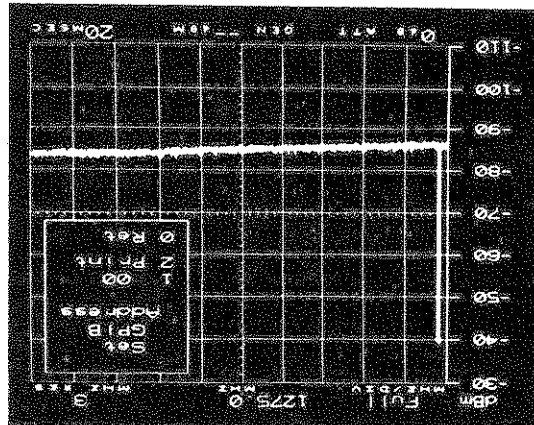

The GPIB Menu appears when the REMOTE Menu is selected and the GPIB option is installed. The GPIB Menu must appear in the menu window before the GPIB Address can be set (see Figure 4-9). The GPIB Address used must match the address specified in the interfacing software.

The RS-232 Menu appears when the REMOTE Menu is selected and the RS-232 option is installed in the A-8000. The RS-232 Menu must appear in the menu window before RS-232 options can be set (see Figure 4-10).

NOTE

Refer to the COMMUNICATIONS Section of the external controller's manual before setting these parameters.

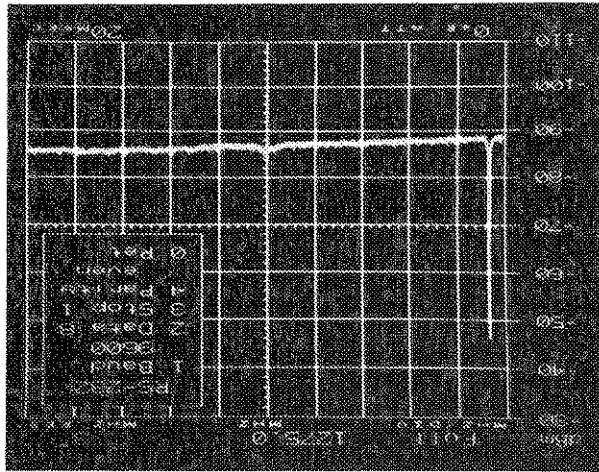

Figure 4-10 RS-232 Menu

To select the Baud Rate, press "1" on the keyboard until the desired Baud Rate appears in the menu window. The following Baud Rates are available on the A-8000: 300, 600, 1200, 2400, 4800, 9600 and 19200 baud. The current setting is displayed in the menu window.



To set the number of Data Bits per word, press "2" on the keyboard until the desired setting appears in the menu window. Data Bits can be set to 7 or 8. The current selection is displayed in the menu window.



To set the number of Stop Bits per word, press "3" on the keyboard until the desired setting appears in the menu window. Stop Bits can be set to 1 or 2. The current setting is displayed in the menu window.



To select the mode of Parity Check, press "4" on the keyboard until the desired mode appears in the menu window. Parity can be set to ODD, EVEN or NONE. The current setting is displayed in the menu window.



To return to the SETUP Menu, press "0" on the keyboard.





To return to the SETUP Menu, press "0" on the keyboard.



To turn the Auto Cal function ON (Acal = 1) or OFF (Acal = 0), press "3" on the keyboard. Setting Auto Cal OFF disables the Auto Cal feature, and displays "Ac" between the Scan Width and Center Frequency display blocks across the top of the CRT display. Returning to the ON state forces one Auto Cal cycle. Set Acal to 1.



To turn Sweep Rate Optimization ON (Swp = A) or OFF (Swp = M), press "2" on the keyboard. When Sweep Rate Optimization is ON, the Sweep Rate may change when the Center Frequency, Scan Width or Resolution Bandwidth is changed. When Sweep Rate optimization is OFF, changing the Center Frequency, the Scan Width or the Resolution Bandwidth does not change the Sweep Rate. "M+" is displayed next to the Sweep Rate display when Bandwidth Optimization is turned OFF. Set Swp to A.



To turn Bandwidth Optimization ON (Bw = A) or OFF (Bw = M), press "1" on the keyboard. When Bandwidth Optimization is ON, the Resolution Bandwidth may change when the Center Frequency or Scan Width is changed. When Bandwidth Optimization is OFF, changing the Center Frequency or the Scan Width does not change the Resolution Bandwidth. "M+" is displayed next to the resolution bandwidth display when Bandwidth Optimization is turned OFF. Set Bw to A.

A-8000 optimization is discussed in Appendix E.

NOTE

Figure 4-11 MANUAL Menu

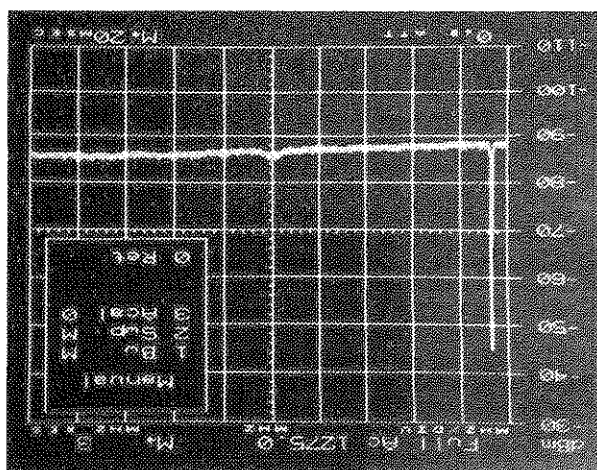

To select the MANUAL Menu, press "4" on the keyboard when the SETUP Menu appears in the menu window. The MANUAL Menu must appear in the menu window before MANUAL Menu parameters can be set (see Figure 4-11).

4-10 TEST MENU

To select the TEST Menu, press "5" on the keyboard when the SETUP Menu appears in the menu window. When selected, all tests are automatically run. Once the tests are completed, any test can be rerun by pressing the number on the keyboard corresponding with the number of the desired test in the menu window. A passed test is indicated by "P" displayed to the right of the test in the menu window. A failed test is indicated by "F" displayed in reverse video to the right of the test in the menu window (e.g., see "RF" in Figure 4-12).

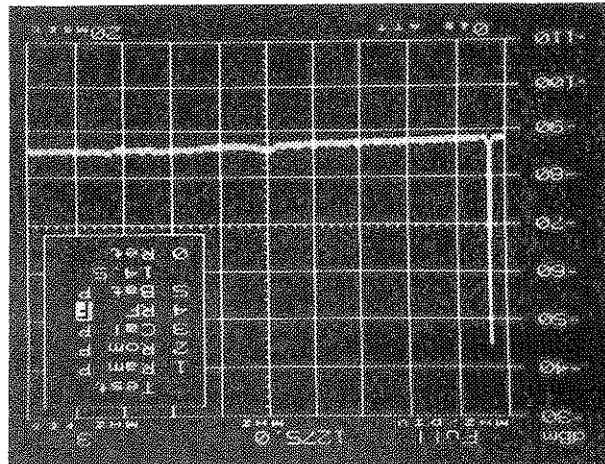

Figure 4-12 TEST Menu

To rerun the RAM test only, press "1" on the keyboard. This tests system RAM, CRT alpha RAM, and the Dual-port RAM. If all RAM tests pass, "P" is displayed in the menu window next to the RAM test. If any of the tests fail, they are indicated in reverse video as follows:

- F1 - System RAM on Control Processor Board failure;
- F2 - CRT alpha RAM on Video Processor Board failure;
- F3 - Dual-port RAM on Video Processor Board failure.

To rerun the ROM test only, press "2" on the keyboard. This performs a checksum test on the system firmware.

To rerun the CAL test only, press "3" on the keyboard. This tests the Auto Cal subsystem.

To rerun the RF test only, press "4" on the keyboard. This tests the microprocessor communication between the RF interface and all PC Boards. Phase lock condition is indicated by "P"; otherwise, the test fails.



Item 6 of the Master Menu must match the device. Otherwise, the actions of the device will be unpredictable.

NOTE

4. Set the GPIB Menu (see Paragraph 4-8-1) to match item 6 of the Master Menu with the device.
 - a. If plotting, the plotter must be compatible for use with Hewlett Packard Graphics Language (HP-GL); Set the plotter to LISTEN ONLY mode.
 - b. A Hewlett Packard ThinkJet™ printer must be used as the printing device. Set the printer to LISTEN ALWAYS mode.
3.
 - a. If plotting, the plotter must be compatible for use with Hewlett Packard Graphics Language (HP-GL); Set the plotter to LISTEN ONLY mode.
2. Connect a GPIB Cable between the GPIB Connector (37) on the Rear Panel of the A-8000 and the GPIB Connector of the device.
1. Disconnect any GPIB Controller to the A-8000.

The following steps are preliminary to using the A-8000 stored trace for plotting or printing:

4-11-1 PLOTTER/PRINTER INSTALLATION

The Plot and Print Menus can be used only if the GPIB option is installed in the A-8000; otherwise, this menu item is inhibited.

NOTE

4-11 PLOT/PRINT MENUS



To return to the SETUP Menu, press "0" on the keyboard.

When the battery test is performed and the battery is not installed, a voltage reading of the Battery Charge Circuit is taken. The battery test should pass and the reading should be 14.5 V.

NOTE



To rerun the BATT test only, press "5" on the keyboard. This checks the battery charge level and displays the voltage in 0.5 V intervals (rounded down) of the measured voltage. If below +12 V, a failure condition is indicated.

4-11-2 PLOTTER OPERATION

The plot function plots a graph of a stored trace. To store a trace and plot it:

1. Select the MODE Menu. If the menu function is active, press:



If the Menu function is inactive, press:



2. Store the trace to be plotted. Press .
3. Select the Plot Menu. Press .
4. Select Plotter functions per Paragraph 4-11-3.

NOTE

Be sure the plotter is set up with pen(s) and paper before engaging the plotter function.

During plotter operation, the arrow in the menu window points to the active task (see Figure 4-13a). The arrow disappears when the task completes (see Figure 4-13b).

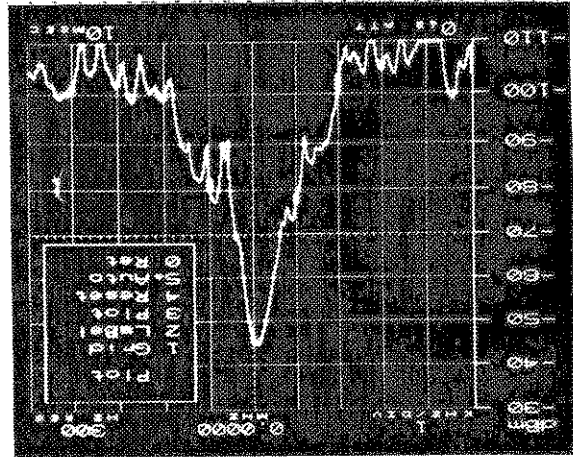

(a) Plot Menu During Plotter Activity

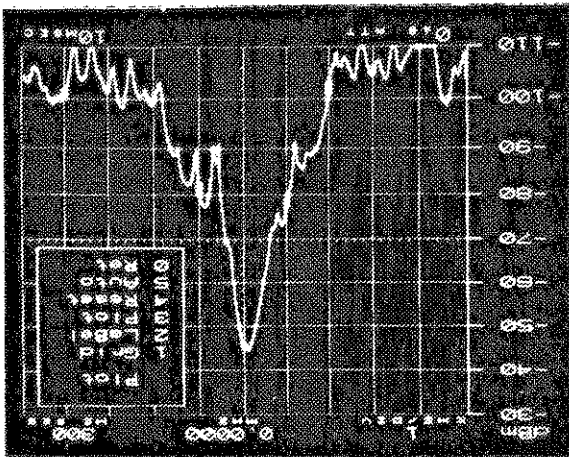

(b) Plot Menu When Waiting for Activity

Figure 4-13 PLOT Menus

4-11-3 PLOT MENU FUNCTIONS

- Pen 1 is used to draw the trace only;
- Pen 2 is used to draw the grid, parameter labels and values;
- Pens 1 and 2 MUST be inserted for proper plotter operation;
- The Auto menu function (menu function "5") may be used for uninterupted operation.

When using a multiple pen plotter:

When using a single pen plotter, if more than one color is desired for the plot, the stylus must be changed manually between plotter functions. In this case, use menu functions 1, 2 and 3 during plotter operation. If only one color is desired for the entire plot, menu function 5 (Auto) may be used for uninterupted plotter operation.

To draw the grid on the plotter, press "1" on the keyboard. This grid represents all graticules and tick markings of the A-8000.



To draw labels and parameter values of the stored trace, press "2" on the keyboard.



To draw the stored trace on the plotter, press "3" on the keyboard.



To stop any of the above functions before completion, press "4" on the keyboard. If the function is subsequently rerun, the plotter begins to draw at the starting position of the selected function.





The Auto selection performs the functions of selections 1, 2 and 3 without interruption. Press "5" on the keyboard to select "auto" operation.





To return to the Master Menu, press "0" on the keyboard.





The Print function prints a graph of a stored trace. To store a trace and print it:

1. Select the MODE Menu. If the menu function is active, press:
 - 
 - 
 - 

If the menu function is inactive, press:

- 
- 

2. Store the trace to be plotted. Press:
 - 

3. Select the Print Menu. Press:
 - 
 - 

4. Select the Printer function. Press:
 - 

During printer operation, the arrow in the menu window points to the active task (see Figure 4-14a). The arrow disappears when the task completes (see Figure 4-14b).

NOTE

The printer ejects a page before it begins printing. The printer operates for approximately two and one-half minutes, until it completes the task.

(a) Print Menu During Printer Activity
 (b) Print Menu When Waiting for Activity

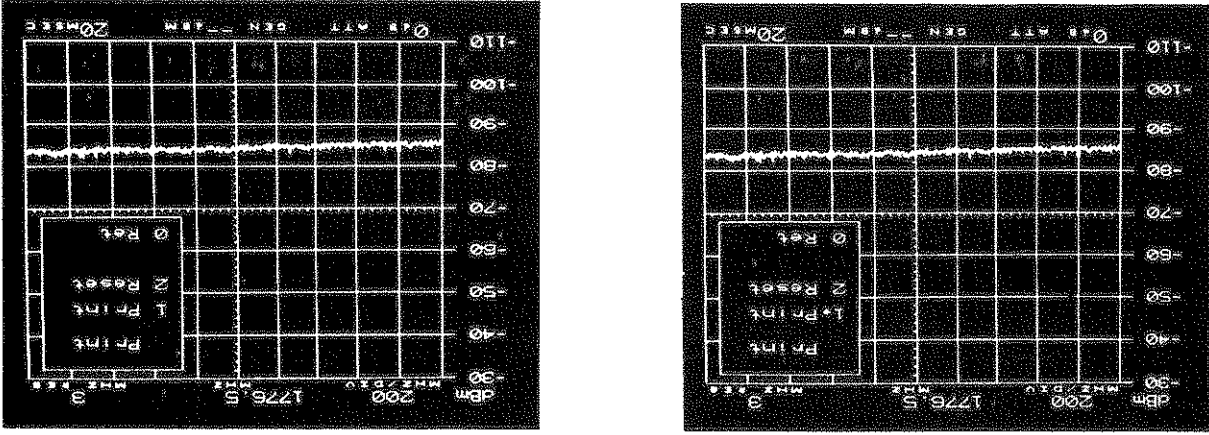
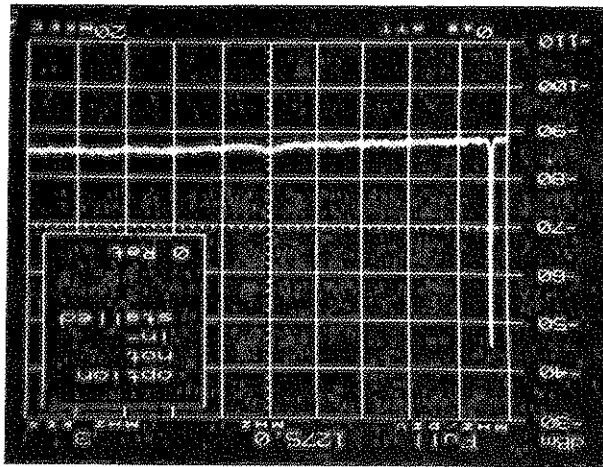

Figure 4-14 PRINT Menus

Press "0" on the keyboard to return to the previous menu.



Figure 4-15 OPTION NOT INSTALLED Menu



OPTION NOT INSTALLED is a message menu that appears when a selected option is not installed in the A-8000. For example, if the RCVR Menu is selected and the 10.7 MHz Receiver is not in the unit, OPTION NOT INSTALLED will be displayed in the menu window (see Figure 4-15).

4-12 OPTION NOT INSTALLED MENU

- Press "1" on the keyboard to print the stored trace directly on the printer.
- Press "2" on the keyboard to stop the print operation while it is in progress. The print operation may then be restarted, if desired, by pressing "1".
- Press "0" to return to the Master Menu when printing is completed.



4-11-5 PRINTER MENU FUNCTIONS

This section contains procedures to familiarize the user with the control panel on the A-8000 Spectrum Analyzer. The procedures cover a standard A-8000 Spectrum Analyzer, and operation for the 75Ω, 10.7 MHz Receiver and Tracking Generator options. None of the procedures require internal access to the unit. Throughout the procedures, numbers in parentheses refer to the front and Rear Panels (Figs. 3-1 and 3-2). It may also be necessary to refer to Figures 3-3 (CRT display) and 4-1 (Menu displays) until the user is familiar with the unit.

Several procedures are included in this manual for GPIB (Section 6), RS-232 (Section 7) and Quasi-Peak Filter (Section 8) operation. Refer to the appropriate section(s) of this manual to use any of these procedures.

OPERATING NOTES:

ANNUNCIATOR
Beeps only if key entry is valid and is accepted by the microprocessor. Volume is controlled by the ANNUNCIATOR Volume Adjust (23). (VOLUME Control (24) is for demod audio and applies only to the 10.7 MHz Receiver option.)

NUMERIC/ENTER KEYS
(6) are used to enter a Center Numeric Keys or select a Menu function. ENTER (8) must be pressed, unless entering a Center Frequency with four decimal places right of the decimal point.

FULL SCAN
Pressing "RF,ENTER" (7) (8) sets the Center Frequency to 1275.0 MHz and the Scan Width to 265 MHz/DIV. 265 MHz/DIV is designated as "FULL" in the Scan Width Block on the CRT display (21). Pressing "ENTER" after FULL SCAN is selected changes back to the previously selected parameters.

GRATICULE LABELS
The microprocessor changes the graticule labels based on Rf attenuation, If Gain, Impedance or Graticule Unit selection (see Paragraph 3-3-1). In all cases, the level of an input signal is the actual level displayed on the CRT.

5-2 A-8000 OPERATION PROCEDURES

5-2-1 PROCEDURE FOR STANDARD A-8000 UNIT

Selecting 75Ω impedance only changes the setting and graticule scales. If operating at 75Ω, a 75Ω adapter must be connected to the ANALYZER INPUT Connector (20).

NOTE

Alternates graticule display between 50Ω and 75Ω settings. Select 50Ω.

Returns to SETUP Menu.

Individual tests can be run by pressing the numeric key equivalent of the test in the menu window.

NOTE

Verifies TEST Menu appears on CRT display and all tests Pass (i.e., "P" is indicated in menu window following each test).

Verifies SETUP Menu appears on the CRT display.

Verifies Master Menu appears on CRT display.

Sets CRT display to desired contrast. Use a small non-magnetic screwdriver or a tuning tool for the GRATICLE Intensity Adjust.

The IFR logo should disappear, replaced by the graticule display.

Power On Indicator (15) should light up and the IFR logo should appear on the CRT display (21).

Outlet must meet requirements stated in Paragraph A-5.

RESULT/NOTE

STEP ACTION

1. Connect AC Power Cord to AC Power Connector (29) and Plug into electrical outlet.

2. Set PMR/OFF/BATT Switch (14) to "PMR".

3. Wait approximately ten seconds or press any key.

4. If necessary, adjust TRACE Intensity Control (25) and GRATICLE Intensity (24).



5. Press:



6. Press:



7. Press:



8. Press:



9. Press:

STEP

2.

3.

4.

5.









6.

7.

8.

9.

RESULT/NOTE

STEP	ACTION	RESULT/NOTE
10.	 Press:	Verifies MANUAL Menu appears on CRT display.
11.	 Press:	Alternates between Bandwidth Optimization and Manual Bandwidth selection. When optimization is active, Bw = A is displayed in the menu window. When optimization is inactive, Bw = M is displayed in the menu window and the Manual Bandwidth Indicator (M+) appears on the CRT Display. Set menu to indicate Bandwidth Optimization is active. The Manual Bandwidth Indicator should disappear.
12.	 Press:	Alternates between Sweep Rate Optimization and Manual Sweep Rate selection. When optimization is active, Swp = A is displayed in the menu window. When optimization is inactive, Swp = M is displayed in the menu window and the Manual Bandwidth Indicator (M+) appears on the CRT Display. Set menu to indicate Sweep Rate Optimization is active. The Manual Indicator should disappear.
13.	 Press:	Alternates between Auto Calibration (Auto Cal) active or inactive. When Auto Cal is active, Acal = 1 is displayed in the menu window. When Auto Cal is inactive, Acal = 0 is displayed in the menu window and the Auto Cal Indicator (Ac) appears in the CRT Display. Set menu to indicate Auto Cal is active. The Auto Cal Indicator should disappear.
14.	 Press:	Menu should disappear and reappear with Master Menu in menu window.
15.	 Press:	Verifies DISPLAY Menu appears.
16.	 Press:	Selects LINE mode of operation.
17.	 Press:	Returns to Master Menu.

Only significant digits appear in the Center Frequency display. Significant digits are determined, in part, by Scan Width. Sets RF ATTEN to 10 dB. Press RF ATTN key (up or down) until the desired level appears in the RF ATTENUATION display block on the CRT display. Sets Scan Width to 1 MHz/DIV. Press one of the Scan Width keys until 1 MHz/DIV appears in the Scan Width display block on the CRT display. Sets Gaticule Scale to 10 dB/DIV. Press one of the LOG/LIN keys until the gaticules at each major division are 10 dB apart. Steps down IF GAIN. Continue to step down the IF GAIN until top gaticule reads -20 dBm.

NOTE

Sets Center Frequency to 100.00 MHz.

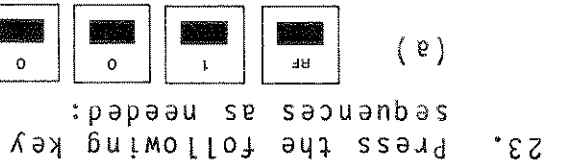
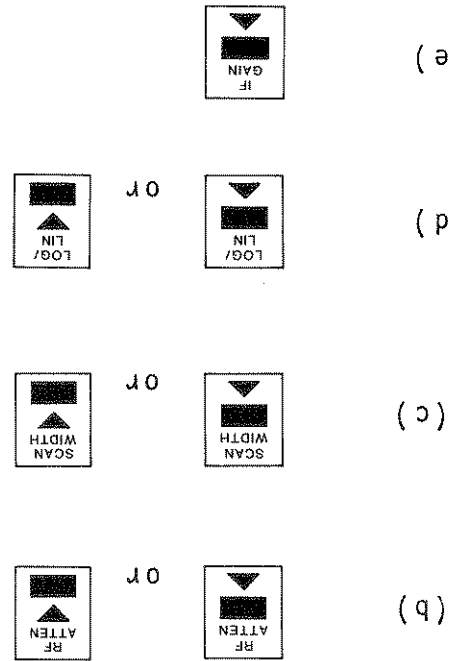

STEP	ACTION	RESULT/NOTE
18.	Press:	Selects MODE Menu.
19.	Press:	Selects LIVE mode of operation.
20.	Press:	Returns to Master Menu.
21.	Press:	Selects FILTERS Menu.
22.	Press:	Selects NO FILTER option, then clear the Menu display.

Steps up IF GAIN in 1 db steps. Continue to step up IF GAIN 10 db and watch the entire display, including the noise floor, drop with each step.

Steps down IF GAIN in 1 db steps. Continue to step down IF GAIN 10 db and watch the entire display, including the noise floor, drop with each step.





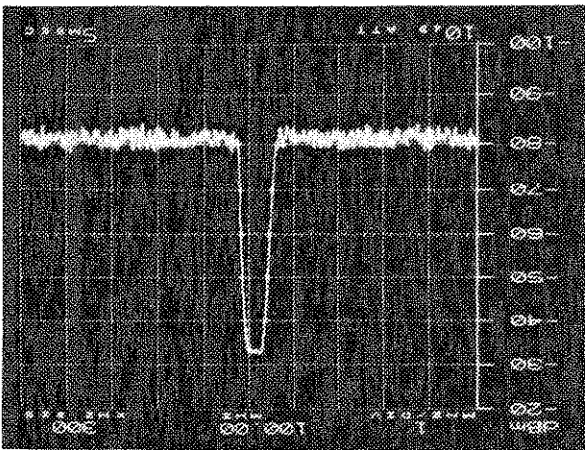

Steps up the RF Attenuation 10 db. The noise floor does not change, but the graticule display changes. Selects FULL Scan. The Center Frequency setting is 1275.0 MHz. The cursor should appear at the 100 MHz digit of the Center Frequency display.

Figure 5-1 REF OUT Signal Display



CRT display should be similar to Figure 5-1.

RESULT/NOTE

- 29. Press: 
- 28. Press:  
- 27. Press: 
- 26. Press: 
- 25. Press: 

ACTION

STEP

24. Connect 50Ω Type-N-to-BNC Coax Cable from REF OUT (19) to ANALYZER INPUT (20).

STEP

ACTION

RESULT/NOTE

30. With the cursor lit, rotate the FREQUENCY control cw.

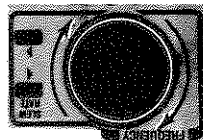

1. The Center Frequency increases in multiples of 100 MHz.
2. The "FULL" indicator is immediately replaced by the 250 MHz/DIV Scan Width setting.
3. The Center Frequency cannot be incremented to a value greater than 2500 MHz.
4. If attempting to scan frequencies greater than 3000 MHz, the Scan Width automatically changes (see Table 3-4).

31. Press :



until the cursor disappears and rotate the FREQUENCY control cw.

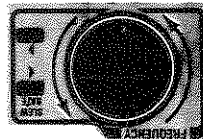

1. The Center Frequency now decreases relative to the Scan Width setting (.1 X Scan Width).
2. The Center Frequency cannot be decremented to a value less than 0 Hz.
3. If attempting to "scan" frequencies less than -50 MHz, the Scan Width automatically changes (see Table 3-4).

32. Press :

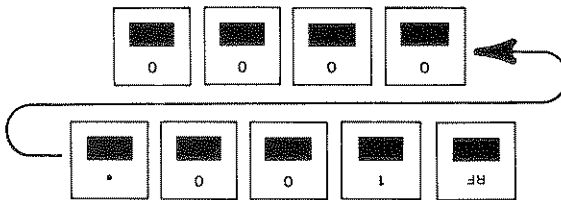

Resets the Center Frequency to 100 MHz. (The ENTER Key (8) function is performed automatically.)

33. Press :



The CRT display changes as the SCAN WIDTH decreases. The shape of the signal changes relative to the Resolution Bandwidth vs. the Scan Width (see Appendix D). Scan Width should step down to 0 KHZ/DIV.

34. Press :



Resets Scan Width to 10 KHZ/DIV.

The parameters from the STORED trace are displayed ONLY in RECALL mode.

NOTE

Selects RECALL mode to observe the stored display. Display should be similar to Figure 5-2.

When "3" is pressed, the arrow in the menu momentarily points to "3" and returns to the previous mode of operation.

NOTE

Stores the display in memory.

Figure 5-2 Live Trace to be Stored

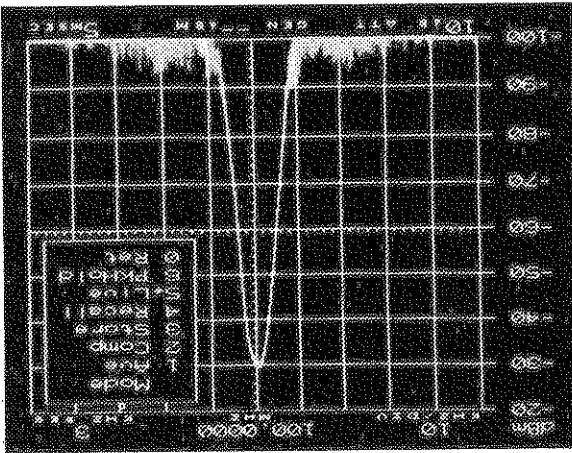

Returns to LIVE operation mode.

Selects AVERAGE mode of operation. The noise level in the display should be reduced.

Re-enters Menu mode and selects MODE Menu.

RESULT/NOTE



39. Press:



38. Press:



37. Press:



36. Press:



35. Press:

ACTION

STEP

In compare mode, only the current parameters (LIVE) are displayed on the CRT display.

NOTE

The shaded area on the CRT display represents the difference between the stored (Figure 5-2) signal and the LIVE (Figure 5-3) signal (i.e., 20 dB amplitude difference with same RF).

Figure 5-3 Signal with 30 dB RF ATTEN

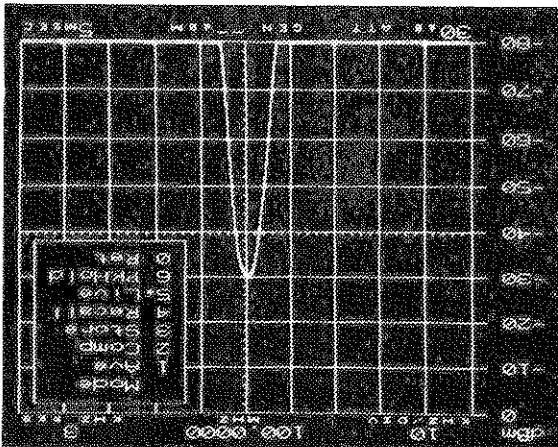

Adds 20 dB RF Attenuation to signal. This increases the level of RF ATTEN to 30 dB and drops the signal amplitude on the CRT display 2 major divisions (compare Figure 5-2 to Figure 5-3).

Returns to LIVE operation mode.

RESULT/NOTE

STEP ACTION



41. Press:



40. Press:



42. Press:

This procedure can only be used if the optional 50 to 75Ω Adapter is available for your unit. The procedure requires a Signal Generator with 75Ω output impedance.

NOTE

5-2-2 75Ω OPERATION PROCEDURE

END OF TEST

47. Press:  Clears the Menu display from the CRT display.



46. Press:    Returns to Master Menu, selects MODE Menu and sets it to LIVE Mode.

Figure 5-6 REF Mode Signal Display



Sets RF ATTEN to 10 dB. The signal should now be represented, basically, as a straight line, as in Figure 5-6. This display shows equal amplitude and frequency.



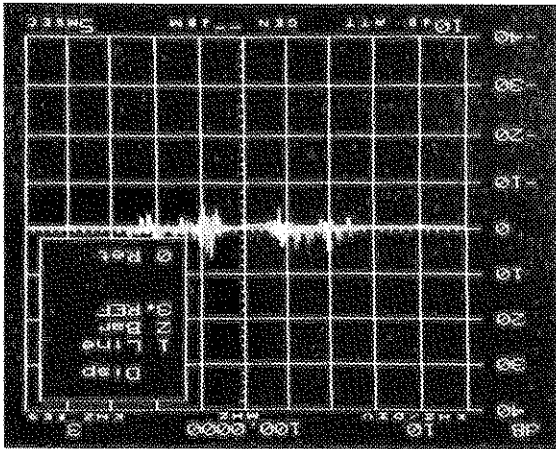

















RESULT/NOTE



ACTION

45. Press:

STEP

1. Connect 75Ω adapter(s) to ANALYZER INPUT Connector (20). Enables A-8000 to operate at 75Ω impedance.
2. Press:    Enters Menu Mode and selects 75Ω operation in the SETUP Menu.
3. Press:  Selects "dBm" for the Graticule Scale.
4. Press  Selects the MANUAL Menu.
5. Press:  Sets Bandwidth Optimization to AUTOMATIC (BW = A)
6. Press:  Sets Sweep Rate Optimization to AUTOMATIC (Swp = A).
7. Press:  Sets Auto Cal feature ON (Acal = 1).
8. Press:    Returns to the Master Menu and selects the LINE display in the DISP Menu.
9. Press:    Returns to the Master Menu and selects the LIVE mode in the MODE menu.
10. Press:    Returns to the Master Menu and selects NONE in the FILTERS Menu.
11. Press:   Sets the Center Frequency to RF Frequency of 75Ω Source.
12. Press:  OR  Sets RF Attenuation to 10 dB.
13. Set the Signal Generator as follows:
 - a. RF Frequency = Same as in Step 11.
 - b. MODULATION = NONE
 - c. RF LEVEL = -30 dBm





RESULT/NOTE

ACTION

STEP

- 3. Press any key from 1 to 5. Selects the numeric key equivalent of the modulation mode.

5 = AM2
 4 = AM1
 3 = SSB
 2 = FM2
 1 = FM1





- 2. Press:   Enter the RCVR Menu.
- 1. Press:  nnn.nnn (n = 0 thru 9)  Sets the Center Frequency to the frequency of a local radio or television station.

STEP ACTION RESULT/NOTE

This procedure can only be used if the 10.7 MHz Receiver is installed in your A-8000 Spectrum Analyzer. If the RCVR menu is selected and the 10.7 MHz Receiver is not installed, the "OPTION NOT INSTALLED" Menu will be displayed in the menu window. Press "0" to return to the Master Menu.

NOTE

5-2-3 10.7 MHZ FM/AM RECEIVER OPERATION PROCEDURE (OPTION)

- 14. Connect 75Ω coax cable between Signal Generator and 50 to 75Ω adapter on A-8000. The generated signal should measure -30 dbm.
- 15. Disconnect the Signal Generator and 75Ω Adapter.
- 16. Press:    Resets Graticule Scale and operational settings for 50Ω operation.
- 17. Press:  Clears menu display from CRT.

END OF TEST

STEP ACTION RESULT/NOTE

END OF TEST

Turns TSR OFF (TSR = 0) and clears the Menu from the CRT display.

During TSR operation, the speaker sounds increasingly disrupted as the sweep time becomes slower. Also, CERTAIN KEYS MAY APPEAR TO HAVE AN ACTION DELAY AS KEY ENTRIES ATTEMPTED DURING AUDIO RECEPTION ARE IGNORED (i.e., they are locked out by the controller).



9. Press:

NOTE

Increases Scan Width and listens to demodulated audio.

Sets Time Share Reception (TSR) to ON position (TSR = 1).

Verifies the Squelch Control squelches audio reception and the Volume Control increases and decreases speaker volume level.

Receives the signal. The demodulated audio is heard through the A-8000 speaker.



8. Press:



7. Press:

6. Vary SQUELCH (22) and VOLUME (24) Controls.

5. Connect antenna to ANALYZER INPUT Connector (20).

DISCHARGE YOUR ANTENNA BEFORE CONNECTING IT TO THE ANALYZER INPUT. STATIC DISCHARGE CAN CAUSE SERIOUS DAMAGE TO THE A-8000.

CAUTION

When the set-up is complete, use the following procedure to test the 10.7 MHz FM/AM Receiver operation.

NOTE

Sets Scan Width to 0 KHZ/DIV for fixed tune operation.



4. Press:

RESULT/NOTE

ACTION

STEP



NOTE



This procedure can only be performed if the Tracking Generator is installed in your A-8000 Spectrum Analyzer.

RESULT/NOTE

ACTION

STEP

1. Press:    Press: Turns the Tracking Generator ON (GEN 1).

2. Press:  OR  Press: Sets Tracking Generator level. Repeat until tracking level is -35 dBm.



3. Press:      Press: Sets the Center Frequency to 100.000 MHz.

4. Press:  OR  Press: Sets RF Attenuation to 10 dB.

5. Press:  Press: Clears the menu display.

6. Connect TRACKING GENERATOR (17) to ANALYZER INPUT (20). Uses 50Ω Type-N to Type-N coax cable.

7. Press:  Press: Decreases Scan Width. Repeat until Scan Width is set to 10 kHz/DIV.

8. Press:  OR  Press: Sets Resolution Bandwidth. Repeat until Resolution Bandwidth is 3 kHz. Verify CRT display is as shown in Figure 5-7.

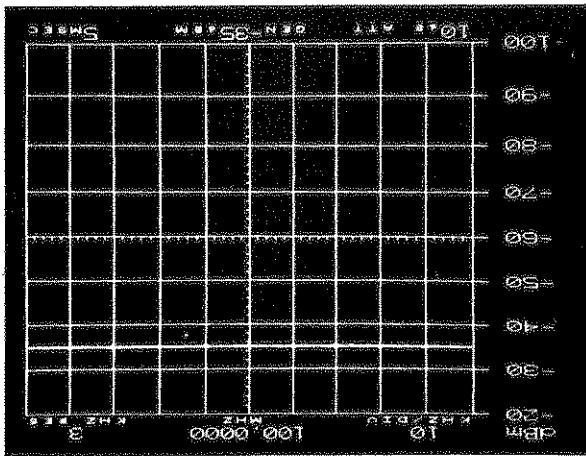









Figure 5-7 Tracking Generator Display

END OF TEST

STEP	ACTION	RESULT/NOTE
9.	Turn Tracking Adjust	Adjusts display for maximum signal amplitude.
10.	Press:  or 	Sets Graticule Scale to 2 dB/DIV.
11.	Press: 	Decreases Generator Output 1 dB. Repeat until Generator Output level decreases 10 dB. The CRT display should change at each 1 dB step.
12.	Press:  	Re-enters Master Menu and selects SETUP Menu.
13.	Press:  	Turns off Tracking Generator.
14.	Press: 	Clears menu display.

Remote communication with the A-8000 is available by using the General Purpose Interface Bus (GPIB). This option conforms to IEEE Standard 488-1978. The test set conforms with the following IEEE Subsets: SH1, AH1, T6, TE0, LA, LE0, SR1, RL2, PP0, DC1, DT1 and CO. These subsets allow the A-8000 to perform the following functions:

Complete Source and Acceptor Handshake

Talker with Serial Port

Listener

Service Request

Remote/local (No local lockout capability)

Device Clear

The GPIB Address is set in the GPIB Menu (see Paragraph 4-8-1).

All communication with the A-8000 through the GPIB requires ASCII encoded character strings. Invalid or improperly formatted characters are discarded and cause an error status bit to be set. Exceptions to this are the IEEE 488-1978 BUS Messages defined in Table 6-2. These messages require immediate attention from the A-8000 to continue processing character strings. The commands are stored in a 128-byte buffer until one of the following messages is received: Carriage Return, Line Feed, Null Character, "END" or "IDY". All commands are then run and measurements made or initiated.

All A-8000 responses returned across IEEE 488-1978 channels are ASCII encoded character strings ending with both CARRIAGE RETURN and LINE FEED commands. (Some controllers may ignore one of these commands.) The EOI message is imparted with the LINE FEED Command.

NOTE

Some command responses (e.g., MODE=STORE; GET(XX)?) have longer than average controller response times. This is expected, and the input time-out parameters for IEEE 488-1978 Controllers should be set to at least thirty seconds.

Porter Address = 31

Once the proper connection is made, the A-8000 can be initialized with the proper address using the GPIB Menu. Refer to Paragraph 4-8-1 for the GPIB Menu instructions.

Table 6-1 Pinout for GPIB Connector

Pin No.	Signal	Pin No.	Signal
1	DIO 1	13	DIO 5
2	DIO 2	14	DIO 6
3	DIO 3	15	DIO 7
4	DIO 4	16	DIO 8
5	EOI	17	REN
6	DAV	18	Ground
7	NRD	19	Ground
8	NDAC	20	Ground
9	IFC	21	Ground
10	SRQ	22	Ground
11	ATN	23	Ground
12	Ground	24	Ground

GPIB Connector pinouts are defined in Table 6-1.

Figure 6-1 GPIB Connector

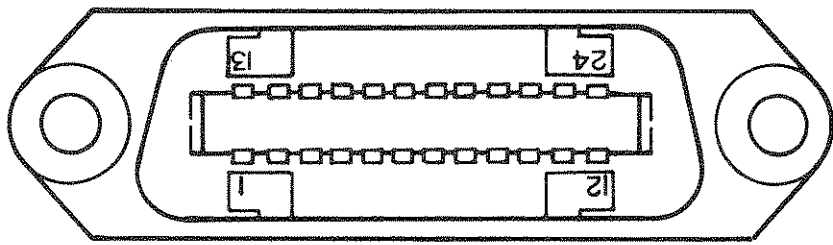

When the GPIB option is installed, a 24-pin connector is provided on the rear panel for connecting the A-8000 to an external controller (see Figure 6-1).

Refer to the IEEE Standard 488-1978 for full definitions.

NOTE

Table 6-2 IEEE 488-1978 BUS Messages

MNEMONIC MESSAGE	ASCII CODE (HEX)	IEEE 488-1978 INSTRUCTION DEFINITION (SEE NOTE)
ATN	bus signal line	ATTENTION
DAB	00-7F	Data Byte
DAC	bus signal line	Data Accepted
DAV	bus signal line	Data Valid
DCL	14	Device Clear
END or EOI	bus signal line	End
GET	08	Group execute trigger
GTL	01	Go to Local
IDY	bus signal line	Identify
IFC	bus signal line	Interface clear
LLO	11	Local Lockout
MLA	20-3F	My listen address
MTA	40-5F	My talk address
REN	bus signal line	Remote enable
RFD	bus signal line	Ready for data
SPD	19	Serial poll disable
SPE	18	Serial poll enable
SRQ	bus signal line	Service Request
STB	00-FF	Status Byte
UNL	3F	Unlisten
UNT	5F	Untalk

ATN The A-8000 GPIB I/O device responds immediately to process the incoming GPIB controller commands.

DAB The A-8000 microprocessor responds by status testing of the GPIB I/O device to accept the data byte.

DAC The A-8000 GPIB I/O device responds immediately to signal the talker that it has accepted the data byte.

DAV The A-8000 GPIB I/O device responds immediately to signal the interceptor that it has put valid data on the BUS.

DCL The A-8000 processor responds to reset the test set to its initialized state.

END or The A-8000 responds to terminate the command input from the source and begin processing the commands available up to the last valid delimiter.

GET The A-8000 responds to terminate any further inputs and executes the commands available up to the last available delimiter.

GTL The A-8000 processor responds to remove itself from control over the test set, therefore returning control to the front panel.

IDY Same as "END" or "EOI".

IFC The A-8000 processor responds by returning to local mode.

LLO No response to this message.

MLA The A-8000 GPIB I/O device responds immediately by comparing its address with the given listen address. If the two are the same, it instructs the processor to listen.

MTA The A-8000 GPIB I/O device compares its address with the talk address given. If the two are the same, it instructs the processor to talk.

REN The A-8000 processor responds from the interface to put the test set into remote, which disables front panel operation.

RFD The A-8000 GPIB I/O device signals the source that it is ready for data to be transmitted on the bus.

SPD The A-8000 GPIB I/O device terminates the service request operation by disabling the serial port.

6-1-2 A-8000 AND GPIB MESSAGE INTERFACE

Following are A-8000 responses to external controller requests during remote communication. Table 6-2 defines each of the mnemonic messages.

The A-8000 GPIB I/O device places the status byte on the BUS addressed to talk.

The A-8000 processor instructs the interface to signal the controller that servicing is desired. (This is done under A-8000 software control.)

STB The A-8000 GPIB I/O device responds immediately after the SPE and MTA messages by placing the status byte on the BUS.

UNL The A-8000 GPIB I/O device and the processor respond to unlisten the test set.

UNT The A-8000 GPIB I/O device and the processor respond to untalk the test set.

6-1-3 GPIB TRANSACTIONS

Following are examples of GPIB transactions showing the ASCII Character String to be transmitted and the corresponding BUS operations required to complete the communication. These examples were generated and run using a GPIB controller with a BASIC Interpreter. Enhancements to the controller allowed direct communication across the GPIB using special GPIB interface hardware.

In the examples, Step 1 shows the transmitted ASCII character string. Step 2 shows the bus operations required to complete the transaction.

A. Example No. 1 - Instruct the A-8000 to set the RF to 500 MHZ.

1. ASCII String: "RFF = 500" (Followed by carriage return and line feed.)
2. BUS Transaction: UNT, UNL, MTA, DAB "R", DAB "F", DAB "F", DAB "=", DAB "5", DAB "0", DAB "0", DAB "0", DAB CR, DAB LF.

B. Example No. 2 - Instruct the A-8000 to return the RF Attenuation which is -10 db.

1. ASCII String: "RFATN?"
2. BUS Transaction:

 - a. Output Cycle - UNT, UNL, MTA, DAB "R", DAB "F", DAB "A", DAB "T", DAB "N", DAB "?", DAB CR, DAB LF.
 - b. Input Cycle - UNT, UNL, MTA, DAB "1", DAB "0", DAB CR, DAB LF.

ASCII QUESTION MARK "?"

ASCII PERIOD "."

ASCII COLON ":" or some other assigned ASCII character

All commands sent to the A-8000 are placed in an internal queue that can accommodate up to 128 bytes of data. Command Strings may be packed together, but the individual commands must be separated by delimiters. The delimiters are:

6-2-1 GPIB COMMANDS TO THE A-8000

All A-8000 functional commands and data information are transferred over the GPIB as uppercase ASCII Alphanumeric Character Strings and are designed to replace the front panel controls.

6-2 COMMAND AND DATA STRUCTURE

Table 6-3 Status Bit Definition

STATUS BIT NO.	STATE	DEFINITION
0	00000001	RAM Error
1	00000010	ROM Error
2	00000100	Autocal test failure
3	00001000	RF test failure
4	00010000	To be defined
5	00100000	A-8000 recognizes remote state
6	01000000	Service Request Bit
7	10000000	ERROR - a command error has occurred

The A-8000 has the capability to trigger a service request, based on one to six trigger conditions which can be set by the user with the "SRQ=" command. After the A-8000 is connected to the controller, it may be interrogated for the one byte status information. If an internal error or status condition becomes true and the matching trigger bit of the SRQ trigger byte (bits 0 through 5) has been set, bit 6 is also set. Bit 6 is generally used as the service request bit, signaling the GPIB controller that the A-8000 desires servicing. For definitions of how status bits are set, see Table 6-3.

6-1-4 STATUS AND SERVICE REQUEST TRANSACTIONS

One of the following line terminators should be included at the end of every line to prevent execution errors from occurring: CR, LF, NL or EOI.

NOTE

SWEPR = 100: SWEPR?
SCANW?
RFATN = 10

All spaces are ignored by the controller. Following are some valid command examples:

6-2-2 GPB COMMAND DATA FORMAT

The external GPB controller must be programmed to expect an ASCII line feed (OA) character as the termination character of the input string.

NOTE

When the A-8000 is assigned talker, the EOI line is set when line feed (OA) is sent.

Carriage Return (OD) - CR
Line Feed (OA) - LF
NULL Character (O) - NL

The following ASCII characters terminate the output command or series of commands:

To avoid confusion or ambiguity, certain characters should not be assigned as delimiters. These include the period, question mark and all numeric and alphabetic characters.

The general delimiter is assigned using the DEL= command. This can be any valid ASCII character with a decimal equivalent of 0 to 127 (e.g., comma (",") = 44, colon (":") = 58 and semicolon (";") = 59.

The Period (".") can be used at any time, but is ignored unless used with the designated commands or as a decimal. Avoid using the period as a general delimiter.

The Question Mark ("?") is accepted at any time, but it is ignored unless it follows a command. This allows the user to continually interrogate the output buffer when waiting for a measurement. Do not use the Question Mark as a general delimiter.

NOTE

Figure 6-2 IEEE 488-1978 Display Output

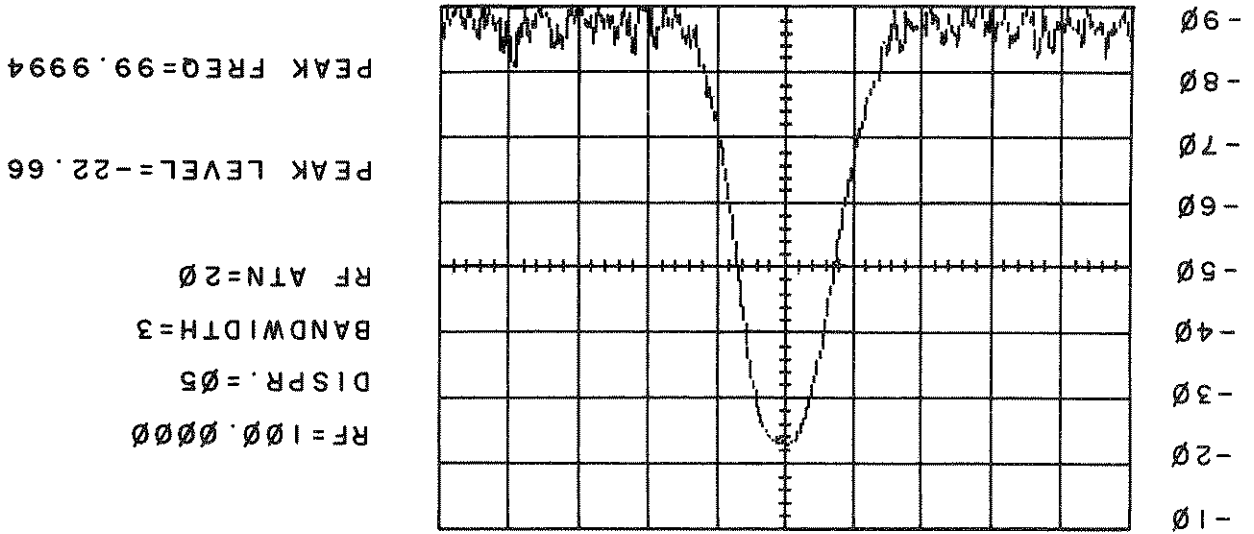

Figure 6-2 shows a reconstructed output produced by an IEEE 488-1978 controller. The requested parameters are listed to the right of the output sample.

Input data that is out of range generally defaults to the minimum value(s) or the initialized value(s).

The returned data format convention is similar to the Output Command Data format in that all returns are packed and separated by the assigned general delimiter(s) and must end with CARRIAGE RETURN and LINE FEED commands. The number of responses returned is determined by the number of commands transferred in one block. If the number of responses required causes the internal response buffer to overflow, because it exceeds 128 characters, then only those characters up to the last delimiter before the 128th character are returned.

6-2-3 RETURN DATA FORMAT

These commands set the Reply Identifier flag which causes the command label following "RID=ON" to be attached to the response.

```
COMMAND: RFF?SCANW?RID=ON:RFATN?
RESPONSE: 500:100:RFATN = 10
```

EXAMPLE:

Maximum command string length, including spaces and delimiters, is 128 characters. If the command string exceeds this length, only those commands prior to the last delimiter and preceding the 128th character are performed. Commands past that delimiter are truncated and the Error Status bit ("7") is then set. Commands ending with an ASCII Question Mark ("?", normally require the user to enter an ASCII String Input Command after issuing an output command.

When the Reply Identifier is activated by the command "RID=ON", the returned information for data or status requests are preceded by the command mnemonic and an "=" character. This continues until the command "RID=OFF" is issued or the A-8000 power is cycled. This feature is especially useful for identifying measured data returned after a time delay, or from a string of commands.

6-3 A-8000 COMMAND SET

Table 6-4 defines, in alphabetic order, the ASCII Commands used to control the A-8000 under GPIB operation. Delimiters for each command are used throughout the table to define different command types:

"=" represents a "set value to" operation for that command.
 "?" represents a "get value" operation for that command.
 "." represents an "enable" operation.

Items listed under the range column reflect data entered into or retrieved from the A-8000. Data shown in parentheses is data retrieved from the unit. Data not enclosed in parentheses is data being sent to the A-8000. A series of dashes means that the command is imperative (no data required as input or output).

NOTE

All commands and data entries must be numeric, one of the assigned delimiters, or an alpha-betic (UPPERCASE or lowercase) character.

NOTE

When entering values for "BW=" or "SCANW=" commands, trailing zeroes right of a decimal will NOT be accepted (e.g.: BW=3.[OK]; SCANW=.03 [OK]; BW=3.0 [REJECTED]; SCANW=.3000 [REJECTED]).

Range must be entered in numeric or alphabetic (UPPERCASE or lowercase) characters.

NOTE

Table 6-4 A-8000 Instruction Set

COMMAND	RANGE	DEFINITION
ACAL	----	Forces one Autocal cycle, if Autocal enabled.
ACAL=	0,1	Disables (0) or Enables (1) Auto Cal feature.
ACAL?	(0,1)	Returns A Cal status (Enabled or Disabled)
BATT?	(11.0 to 15.0 V, 0.5 V steps)	Returns Battery voltage.
BW=	.3,3,30,300,3000 KHZ	Sets Resolution B/W
BW?	(.3,3,30,300,3000 KHZ)	Gets Resolution B/W
BWC=	A or M	Disables (M) or Enables (A) B/W optimization.
BWC?	(A or M)	Returns B/W optimization status.
DEL=	0 to 127, inclusive.	Sets the delimiter to the ASCII character represented by the assigned decimal number.
DEL?	(0 to 127)	Returns the decimal number for the ASCII delimiter character.
DISP=	LINE,BAR,REF	Sets display to one of three modes.
DISP?	(LINE,BAR,REF)	Returns display mode of A-8000.
GEN=	1,0	Sets the generator on (1) or off (0).
GEN?	(1,0)	Returns status of Gen Switch.
GENLVL=	0 to 70	Sets generator output level. Depends upon "REF=" and "IMPD=" Command settings.

1. Range must be entered in numeric or alphabetic (UPPERCASE or lowercase) characters.
2. When receiving display data points, values not displayed can be returned. When receiving a STORED REF trace, values can be negative or greater than 511, as this is a computed RATIO (i.e., (stored signal)/(input signal)).

NOTE

Table 6-4 (Continued) A-8000 Instruction Set

COMMAND	RANGE	DEFINITION
GENLVL?	(0 to 70)	Returns generator output level setting.
GET(x)?	(0 to 511)	Returns 10 points out of the 390 stored points from the last stored display beginning with data group xx (1-39). The returned points are separated by the delimiter assigned in the DEL= command (see Note 2).
IFGAIN=	0 to 65, step 1 dB	Sets the IF GAIN to the designated value.
IFGAIN?	(0 to 65)	Gets the IF GAIN value.
IMP D=	50, 75	Sets the impedance (in ohms).
IMP D?	(50, 75)	Gets the impedance value.
MIN?	(0-511:1-390)	Returns the minimum value of the last stored display for the specified horizontal range. The value is returned in the format: (yy:xxx); where yy is the minimum level (0 to 511) corresponding to the requested horizontal value(s) (1 to 390). The range returned can be in the following formats:

Range must be entered in numeric or alphabetic (UPPERCASE or lowercase) characters.

NOTE

Table 6-4 (Continued) A-8000 Instruction Set

DEFINITION	RANGE	COMMAND
<p>MIN? - The entire stored display is scanned for the minimum signal level. MIN(from)? - The stored display is scanned from the specified horizontal value to the end of the display. MIN(from:to) - The stored display is scanned from the first specified point to the second specified point.</p> <p>NOTE</p> <p>These points must be specified in proper sequence (that is, minimum value must be less than or equal to maximum value). The delimiter separating "from:to" and returned requests is assigned with the DEL= command. If no value precedes the delimiter, 1 is assumed to be the first assigned point.</p>		MIN? (cont.)
	<p>AVE,COMP,STORE,RECALL,LIVE,PKHOLD</p>	MODE=
	<p>(AVE,COMP,STORE,RECALL,LIVE,PKHOLD)</p>	MODE?
	<p>Returns A-8000 mode.</p>	

Range must be entered in numeric or alphabetic (UPPERCASE or lowercase) characters.

NOTE

Table 6-4 (Continued) A-8000 Instruction Set

DEFINITION	RANGE	COMMAND
<p>Returns the peak value of the last stored display for the specified horizontal range. The value is returned in the format: (YY:xxx); where YY is the maximum level (0 to 511) corresponding to the requested horizontal value(s) (1 to 390). The range returned can be in the following formats: PEAK? - The entire stored display is scanned for the maximum signal level. PEAK(from)? - The stored display is scanned from the specified horizontal value to the end of the display. PEAK(from:to) - The stored display is scanned from the first specified point to the second specified point.</p> <p>NOTE</p> <p>These points must be specified in proper sequence (that is, minimum value must be less than or equal to maximum value).</p>	<p>(0-511:1-390)</p>	<p>PEAK? PEAK(from)? PEAK(from:to)?</p>

Range must be entered in numeric or alphabetic (UPPERCASE or lowercase) characters.

NOTE

Table 6-4 (Continued) A-8000 Instruction Set

COMMAND	RANGE	DEFINITION
		<p>The delimiter separating "from:to" and returned requests is assigned with the DEL= command. If no value precedes the delimiter, 1 is assumed to be the assigned point.</p>
PEAKF=	NONE, 30K, 300	Sets peak filter value.
PEAKF?	(NONE, 30K, 300)	Gets peak filter value.
PUT (xx) =	0-511	<p>Sends 10 points to the A-8000 to be stored for display beginning with data group xx (1-39). The data must be valid numbers separated by the delimiter assigned with the DEL= command. To display the transferred information, the A-8000 must be in the "recall" mode.</p>
QUASI=	T1, T2, T3	Sets Quasi-Peak filter value.
QUASI?	(T1, T2, T3)	Returns Quasi-Peak filter value.
RCLR=	F1, F2, SSB, AM1, AM2	Sets 10.7 MHZ Receiver Modulation.
RCLR?	(F1, F2, SSB, AM1, AM2)	Returns 10.7 MHZ Receiver Modulation.
REF=	DBM, DBUM, DBV, DBMV, or DBUV	Sets scale reference label.
REF?	(DBM, DBUM, DBV, DBMV, or DBUV)	Returns scale reference label.
RFATN=	0 to 60, step 10 dB	Sets RF Input Attenuator level.

NOTE

1. Range must be entered in numeric or alpha-betic (UPPERCASE or lowercase) characters.
2. See Paragraph 3-4-3 for details on valid scanwidth entries.

NOTE

Table 6-4 (Continued) A-8000 Instruction Set

COMMAND	RANGE	DEFINITION
RFAIN?	(0 to 60, step 10 dB)	Gets RF Input Attenuation level.
RFF=	0000.0000 to 2500.0000	Sets Analyzer Frequency.
RFF?	(0000.0000 to 2500.0000)	Returns Analyzer Frequency.
RID=	ON/OFF	Controls the Reply Identifier Switch. When ON, adds the command name followed by "=" as a prefix to a command's response.
RID?	(ON/OFF)	Returns the current reply identifier status.
SCALE=	2, 10, LIN	Sets Amplitude Scale
SCALE?	(2, 10, LIN)	Gets Amplitude Scale
SCANW=	0; .001 to 250 MHZ/DIV (see Note 2).	Sets Frequency scan range.
SCANW?	(0; .001 to 250 MHZ/DIV)	Gets Frequency scan range.
SRQ=	0X000000 to 1X111111	Sets the GPIB line interrupt mask. An SRQ interrupt occurs for each set error or status condition. These conditions are:

Range must be entered in numeric or alphabetic (UPPERCASE or lowercase) characters.

NOTE

Table 6-4 (Continued) A-8000 Instruction Set

COMMAND	RANGE	DEFINITION
SRQ?	(0X000000 to 1X111111)	Returns the current status of SRQ (see Bit(s), State, Condition in SRQ= Command.
SWEPR=	5 to 10000 MS/DIV in 1-2-5 steps (see Note 2).	Sets Sweep Rate.
SWEPR?	(5 to 10000 MS/DIV in 1-2-5 steps.)	Gets Sweep Rate.
SWPC=	A or M	Disables (M) or Enables (A) Standard Sweep rate Optimization.
SWPC?	(A or M)	Returns Sweep rate Optimization Status.
TEST	-----	Runs all A-8000 diagnostics and returns errors through the serial port or SRQ? Command.
TOP?	(110 to -30)	Returns top of screen scale value. This enhances plotting the spectrum via a host computer.
TSR=	1,0	Sets Time Share Reception (TSR) ON (1) or OFF (0).

CONDITION	STATE	BIT/S
RAM Error	1	0
ROM Error	1	1
Auto Cal	1	2
test failure		3
Rf test failure	1	3
Not used	1	4
Acknowledge	1	5
Remote	1	6
SRQ bit	1	6
Command error	1	7

Table 6-4 (continued) A-8000 Instruction Set

DEFINITION	RANGE	COMMAND
Gets Status of Time Share Reception.	(1,0)	TSR?
Returns the current version of the firmware in the A-8000.	(x.xx)	VER?

SECTION 7 - RS-232 OPERATION

7-1 REMOTE CONTROL (RS-232) OPERATION

Remote communication with the A-8000 is provided by a half-duplex RS-232 type bus. An external controller configured to RS-232 operation is required. The A-8000 becomes a slave to the external controller.

7-1-1 PREPARATION FOR USING RS-232

A 25-pin connector is included on the rear panel, if the A-8000 is to be used for RS-232 communication to an external controller. Figure 7-1 shows the RS-232 connector used with the A-8000.

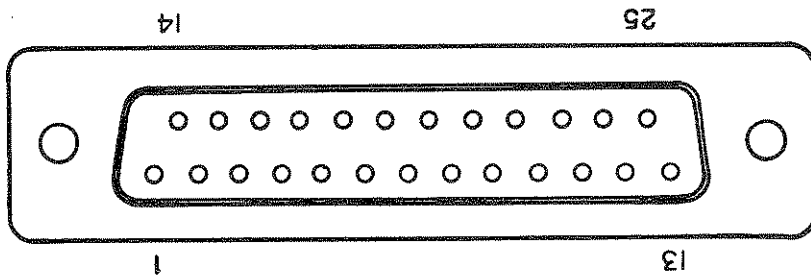

Figure 7-1 RS-232 Interface Connector

The operator must ensure proper interface between the A-8000 and the external controller. Table 7-1 shows the proper pinout for the RS-232 connector.

Pin No (Note 1)	Control Line	Direction (relative to A-8000) (Note 2)
1,7	GROUND	
2	TRANSMIT (TX) DATA	(Output)
3	RECEIVE (RX) DATA	(Input)
4	RTS	(Output)
5	CTS	(Input)
6	DSR	(Input)
8	DCD	(Input)
20	DTR	(Output)

Table 7-1 RS-232 Connector Pinout

NOTE

1. Pin Numbers not listed are not used.
2. Refer to Communications Section of Controller Manual for proper pin number connection of Controller.
3. CTS, DSR and DCD are connected on the interface board with optional jumpers. Some controllers require CTS to be isolated from DSR and DCD. DSR and DCD must be pulled up to enable A-8000 reception.

When the proper connection is made, use the MANUAL Menu on the A-8000 to set the RS-232 communications parameters (it should have the RS-232 option installed). See Paragraph 4-8-2 for parameter descriptions.

7-2 COMMAND AND DATA STRUCTURE

All A-8000 functional commands and data information are transferred over the RS-232 as uppercase ASCII Alphanumeric Character Strings and are designed to replace the front panel controls.

7-2-1 RS-232 COMMANDS TO THE A-8000

All commands sent to the A-8000 are placed in an internal queue that can accommodate up to 128 bytes of data. Command Strings may be packed together, but the individual commands must be separated by delimiters. The delimiters are:

ASCII COLON ":" or some other assigned ASCII character

ASCII PERIOD "."

ASCII QUESTION MARK "?"

NOTE

The Question Mark ("?") is accepted at any time, but it is ignored unless it follows a command. This allows the user to continually interrogate the output buffer when waiting for a measurement. Do not use the Question Mark as a general delimiter.

The Period (".") can be used at any time, but is ignored unless used with the designated commands or as a decimal. Avoid using the period as a general delimiter.

The general delimiter is assigned using the DEL= Command. This can be any valid ASCII character with a decimal equivalent of 0 to 127 (e.g., comma (",") = 44, colon (":") = 58 and semicolon (";") = 59.

To avoid confusion or ambiguity, certain characters should not be assigned as delimiters. These include the period, question mark and all numeric and alphabetic characters.

These commands set the Reply Identifier Flag which causes the command label following "RID=ON" to be attached to the response.

COMMAND: RFF?SCANW?RID=ON:RFATN?
RESPONSE: 500:100:RFATN = 10

EXAMPLE:

Maximum command string length, including spaces and delimiters, is 128 characters. If the command string exceeds this length, only those commands prior to the last delimiter and preceding the 128th character are performed. Commands past that delimiter are truncated and the Error Status bit ("S7") is then set. Commands ending with an ASCII question Mark ("?") normally require the user to enter an ASCII String Input Command after issuing an output command.

CR, LF or NL

One of the following line terminators should be included at the end of every line to prevent execution errors from occurring:

NOTE

SWEEPR = 100: SWEEPR?
SCANW? RFATN = 10

All spaces are ignored by the controller. Following are some valid command examples:

7-2-2 RS-232 COMMAND DATA FORMAT

The external RS-232 controller must be programmed to expect an ASCII line feed (0A) character as the termination character of the input string.

NOTE

Carriage Return (0D) - CR
Line Feed (0A) - LF
NULL Character (0) - NL

The following ASCII Characters terminate the output command or series of commands:

When entering values for "BW=" or "SCANW=" commands, trailing zeroes right of a decimal will NOT be accepted (e.g.: BW=3.03 [OK]; SCANW=.03 [OK]; BW=3.0 [REJECTED]; SCANW=.3000 [REJECTED]).

NOTE

All commands and data entries must be numeric, one of the assigned delimiters, or alphabetic (UPPERCASE or lowercase) characters.

NOTE

Items listed under the range column reflects data entered into or retrieved from the A-8000. Data shown in parentheses is data retrieved from the unit. Data not enclosed in parentheses is data being sent to the A-8000. A series of dashes means that the command is imperative (no data required as input or output).

"=" represents a "set value to" operation for that command.
 "? " represents a "get value" operation for that command.
 "." represents an "enable" operation.

Table 7-2 defines, in alphabetic order, the ASCII commands used to control the A-8000 under RS-232 operation. Delimiters for each command are used throughout the Table to define different command types:

7-3 A-8000 COMMAND SET

When the Reply Identifier is activated by the command "RID=ON", the returned information for data or status requests are preceded by the command mnemonic and an "=" character. This continues until the command "RID=OFF" is issued or the A-8000 power is cycled. This feature is especially useful for identifying measured data returned after a time delay, or from a string of commands.

7-2-4 REPLY IDENTIFIER

Input data that is out of range generally defaults to the minimum value(s) or to the initialized value(s).

The returned data format convention is similar to the Output Command Data Format in that all returns are packed and separated by the assigned general delimiter(s) which must end with CARRIAGE RETURN and LINE FEED commands. The number of responses returned is determined by the number of commands transferred in one block. If the number of responses required causes the internal response buffer to overflow, because it exceeds 128 characters, then only those characters up to the last delimiter before the 128th character are returned.

7-2-3 RETURN DATA FORMAT

Range must be entered in numeric or alphabetic (UPPERCASE and lowercase) characters.

NOTE

Table 7-2 A-8000 Instruction Set

COMMAND	RANGE	DEFINITION
ACAL	----	Forces one Auto Cal cycle, if Auto Cal is enabled.
ACAL=	0,1	Disables (0) or Enables (1) Auto Cal feature.
ACAL?	(0,1)	Returns A Cal status (Enabled or Disabled)
BATT?	(11.0 to 15.0 V, 0.5 V steps)	Returns battery voltage.
BW=	.3,3,30,300,3000 KHZ	Sets Resolution B/W
BW?	(.3,3,30,300,3000 KHZ)	Gets Resolution B/W
BWC=	A or M	Disables (M) or Enables (A) B/W optimization.
BWC?	(A or M)	Returns B/W optimization status.
DEL=	0 to 127, inclusive.	Sets the delimiter to the ASCII character represented by the assigned decimal number.
DEL?	(0 to 127)	Returns the decimal number for the ASCII delimiter character.
DISP=	LINE,BAR,REF	Sets display to one of three modes.
DISP?	(LINE,BAR,REF)	Returns display mode of A-8000.
GEN=	1,0	Sets the generator on (1) or off (0).
GEN?	(1,0)	Returns status of Gen Switch.
GENVL=	0 to 70	Sets generator output level. Depends upon "REF=" and "IMPD=" command settings.

1. Range must be entered in numeric or alphabetic (UPPERCASE or lowercase) characters.
2. When receiving display data points, values not displayed can be returned. When receiving a STORED REF trace, values can be negative or greater than 511, as this is a computed RATIO (i.e., (stored signal)/(input signal)).

NOTE

Table 7-2 (continued) A-8000 Instruction Set

COMMAND	RANGE	DEFINITION
GENLVL?	(0 to 70)	Returns generator output level setting.
GET(xx)?	(0 to 511)	Returns 10 points out of the 390 stored points from the last stored display beginning with data group xx (1-39). The returned points are separated by the delimiter assigned in the DEL= command (see Note 2).
IFGAIN=	0 to 65, step 1 dB	Sets the IF GAIN to the designated value.
IFGAIN?	(0 to 65)	Gets the IF GAIN value.
IMPDP=	50, 75	Sets the impedance (in ohms).
IMPDP?	(50, 75)	Gets the impedance value.
MIN?	(0-511:1-390)	Returns the minimum value of the last stored display for the specified horizontal range. The value is returned in the format: (yy:xxx); where yy is the minimum level (0 to 511) corresponding to the requested horizontal value(s) (1 to 390). The range returned can be in the following formats:

Range must be entered in numeric or alphabetic (UPPERCASE or lowercase) characters.

NOTE

Table 7-2 (continued) A-8000 Instruction Set

DEFINITION	RANGE	COMMAND
<p>MIN? - The entire stored display is scanned for the minimum signal level. MIN(from)? - The stored display is scanned from the specified horizontal value to the end of the display. MIN(from:to) - The stored display is scanned from the first specified point to the second specified point.</p>		MIN? (cont.)
<p>NOTE</p> <p>These points must be specified in proper sequence (that is, minimum value must be less than or equal to maximum value). The delimiter separating "from:to" and returned requests is assigned with the DEL= command. If no value precedes the delimiter, it is assumed to be the first assigned point.</p>	<p>AVE,COMP,STORE,RECALL,LIVE, PKHOLD</p>	MODE=
<p>Returns A-8000 mode.</p>	<p>(AVE,COMP,STORE,RECALL,LIVE, PKHOLD)</p>	MODE?

Range must be entered in numeric or alphabetic (UPPERCASE or lowercase) characters.

NOTE

Table 7-2 (Continued) A-8000 Instruction Set

DEFINITION	RANGE	COMMAND
<p>Returns the peak value of the last stored display for the specified horizontal range. The value is returned in the format: (YY:xxx); where YY is the maximum level (0 to 511) corresponding to the requested horizontal value(s) (1 to 390). The range returned can be in the following formats:</p> <p>PEAK? - The entire stored display is scanned for the maximum signal level.</p> <p>PEAK(from)? - The stored display is scanned from the specified horizontal value to the end of the display.</p> <p>PEAK(from:to) - The stored display is scanned from the first specified point to the second specified point.</p> <p>NOTE</p> <p>These points must be specified in proper sequence (that is, minimum value must be less than or equal to maximum value).</p>	<p>(0-511:1-390)</p>	<p>PEAK? PEAK(from)? PEAK(from:to)?</p>

Range must be entered in numeric or alphabetic (UPPERCASE or lowercase) characters.

NOTE

Table 7-2 (Continued) A-8000 Instruction Set

COMMAND	RANGE	DEFINITION
PEAKF =	NONE, 30K, 300	Sets peak filter value.
PEAKF ?	(NONE, 30K, 300)	Gets peak filter value.
PUT (xx) =	0-511	Sends 10 points to the A-8000 to be stored for display beginning with data group xx (1-39). The data must be valid numbers separated by the delimiter assigned with the DEL= command. To display the transferred information, the A-8000 must be in the "recall" mode.
QUASI =	TCl, TC2, TC3	Sets Quasi-Peak filter value.
QUASI ?	(TCl, TC2, TC3)	Returns Quasi-Peak filter value.
RCVR =	FM1, FM2, SSB, AM1, AM2	Sets 10.7 MHz Receiver Modulation.
RCVR ?	(FM1, FM2, SSB, AM1, AM2)	Returns 10.7 MHz Receiver Modulation.
REF =	DBM, DBUW, DBV, DBMV, or DBUV	Sets scale reference label.
REF ?	(DBM, DBUW, DBV, DBMV, or DBUV)	Returns scale reference label.
RFATN =	0 to 60, step 10 dB	Sets RF Input Attenuator level.

NOTE

The delimiter separating "from:to" and returned requests is assigned with the DEL= command. If no value precedes the delimiter, 1 is assumed to be the assigned point.

DEFINITION

RANGE

COMMAND

1. Range must be entered in numeric or alpha-betic (UPPERCASE or lowercase) characters.
2. See Paragraph 3-4-3 for details on valid scanwidth settings.

NOTE

Table 7-2 (continued) A-8000 Instruction Set

COMMAND	RANGE	DEFINITION
RFAIN?	(0 to 60, step 10 dB)	Gets RF Input Attenuation level.
RFF=	0000.0000 to 2500.0000	Sets Analyzer Frequency.
RFF?	(0000.0000 to 2500.0000)	Returns Analyzer Frequency.
RID=	ON/OFF	Controls the Reply Identifier Switch. When ON, adds the command name followed by "=" as a prefix to a command's response.
RID?	(ON/OFF)	Returns the current reply identifier status.
SCALE=	2, 10, LIN	Sets Amplitude Scale
SCALE?	(2, 10, LIN)	Gets Amplitude Scale
SCANW=	0; .001 to 250 MHZ/DIV (see Note 2).	Sets Frequency scan range.
SCANW?	(0; .001 to 250 MHZ/DIV)	Gets Frequency scan range.
SRQ=	0X000000 to 1X111111	Sets the GPIB line interrupt mask. An SRQ interrupt occurs for each set error or status condition. These conditions are:

Range must be entered in numeric or alphabetic (UPPERCASE or lowercase) characters.

NOTE

Table 7-2 (Continued) A-8000 Instruction Set

COMMAND	RANGE	DEFINITION
SRQ?	(0X000000 to 1X111111)	Returns the current status of SRQ (see Bit(s), State, Condition in SRQ= Command.
SWEPR=	5 to 10000 MS/DIV in 1-2-5 steps (see Note 2).	Sets Sweep Rate.
SWEPR?	(5 to 10000 MS/DIV in 1-2-5 steps.)	Gets Sweep Rate.
SWPC=	A or M	Disables (M) or Enables (A) Standard Sweep rate Optimization.
SWPC?	(A or M)	Returns Sweep rate Optimization Status.
TEST	----	Runs all A-8000 diagnostics and returns errors through the serial port or SRQ? Command.
TOP?	(110 to -30)	Returns top of screen scale value. This enhances plotting the spectrum via a host computer.
TSR=	1,0	Sets Time Share Reception (TSR) ON (1) or OFF (0).

CONDITION	STATE	BIT/S
RAM Error	1	0
ROM Error	1	1
Auto Cal	1	2
test failure	1	3
RF test failure	1	4
Not used	1	5
ACK request	1	6
Not used	1	7
Command error	1	

Table 7-2 (Continued) A-8000 Instruction Set

COMMAND	RANGE	DEFINITION
TSR?	(1,0)	Gets Status of Time Share Reception.
VER?	(x.xx)	Returns the current version of the firmware in the A-8000.

SECTION 8 - QUASI-PEAK OPERATION

8-1 QUASI-PEAK PURPOSE

International agreement and Federal regulations state the need to monitor Electromagnetic Interference (EMI) produced from electronic sources. The guidelines, originally set by Comite International Special des Perturbations Radioelectriques (CISPR), were adapted by the American National Standards Institute (ANSI) and are regulated by the Federal Communications Commission (FCC). Refer to ANSI Standard C63.2-1980 and FCC Rules and Regulations, Volume II, Part 15, Subpart J, for further information.

Quasi-Peak measurements offer a larger dynamic range for measurement of pulsed frequencies than do most common methods of frequency measurement devices (e.g., RMS and peak). The A-8000 Quasi-Peak option is a compact and efficient EMI measurement tool.

8-2 QUASI-PEAK PREREQUISITES

8-2-1 UNITS

The preferred unit for Quasi-Peak measurement is dBV; which results in positive voltage readings. Use menu option 2 of the SETUP Menu (see Paragraph 4-7) to select the dBV parameter.

8-2-2 LINEAR MODE

Quasi-Peak measurements are valid in LINEAR Mode only. Time constants cannot be amplified and weighted using a logarithmic scale. Appendix C supplies values for calculating the signal amplitude when reading the A-8000 linear scale. The signal amplitude is calculated using the formula:

$$A = T + (20 \text{ Log } (D \div 8))$$

T is the Top of Scale value and D is the number of divisions from the bottom graticule on the screen (see Figure 8-1).

NOTE

Appendix C applies to all readings using the Linear Scale. Quasi-Peak is only one application of this scale.

The top 87.5% of the Linear Scale spans an 18 dB range. For more accurate readings, adjust amplitude readings to the upper-middle segment of the screen.

NOTE

When adjusting IF GAIN, avoid introducing compression into the signal measurement.

Table 8-1 Optimum Sweep Rates for TC2 and TC3

TC2		TC3	
SCANWIDTH (KHZ/DIV)	SWEEP RATE (Sec/DIV)	SCANWIDTH (KHZ/DIV)	SWEEP RATE (Sec/DIV)
1	.1	1	.1
2	.2	2	.1
5	.5	5	.1
10	1	10	.1
20	2	20	.2
--	--	50	1
--	--	100	1

Figures 8-2 through 8-4 illustrate the amplitude error for each time constant at sweep times and frequency spans available on the A-8000. The graphs show empirical data. Table 8-1 suggests the optimum sweep rates for TC2 and TC3 operation. It is not possible to scan in TC1 without appreciable amplitude error.

The peak level of a CW signal equals the Quasi-Peak level. The amplitude of a Quasi-Peak measurement must be less than or equal to the level at a peak measurement.

8-2-4 CONTINUOUS WAVE SIGNALS

For most Quasi-Peak measurements, set the Scan Width to zero. If the Scan Width selected for Quasi-Peak is not zero, then set the Sweep Rate to a slow enough setting so the charge and discharge times do not interfere with measurements. It is suggested that the operator force one Auto Cal cycle (see Paragraph 4-9) before starting EMI measurements. In Quasi-Peak Mode, Bandwidth and Sweep Rate optimization does not occur.

8-2-3 SCAN WIDTH SELECTION

Figure 8-1 Linear Scale

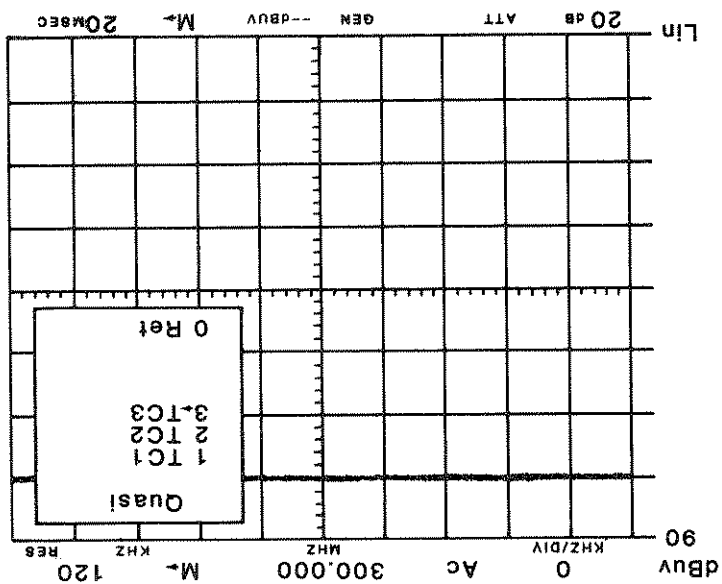

Figure 8-4 TC3 Amplitude Error (Frequency Range: 30 MHz to 1 GHz)

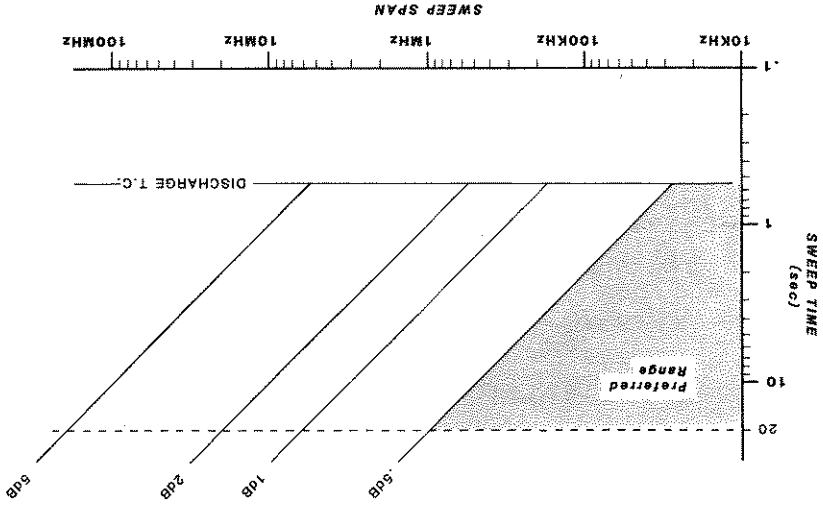

Figure 8-3 TC2 Amplitude Error (Frequency Range: 150 KHz to 30 MHz)

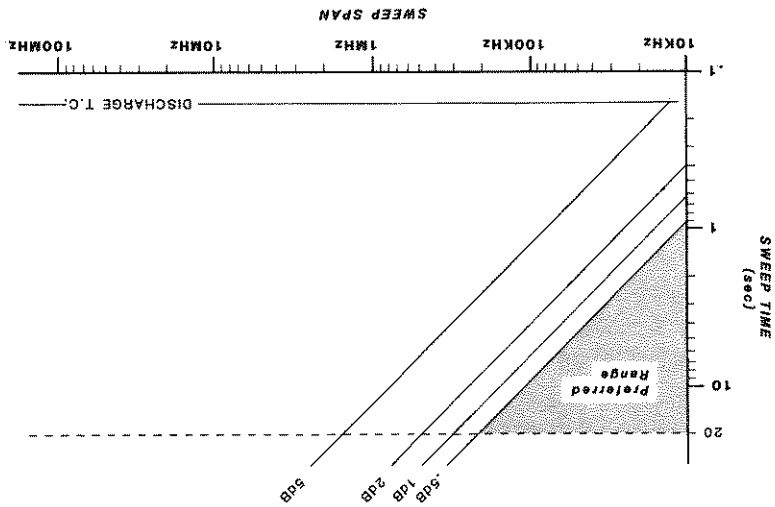
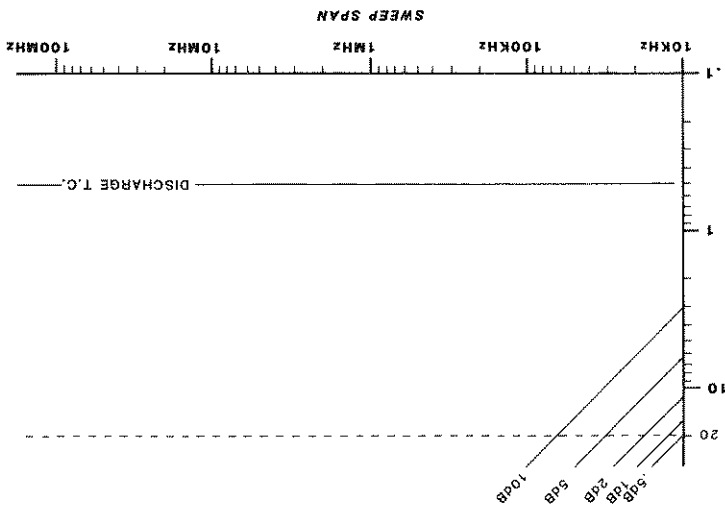

Figure 8-2 TC1 Amplitude Error (Frequency Range: 10 to 150 KHz)



The antenna factor is supplied by the manufacturer of the equipment. This is a conversion factor required to convert the indicated voltage value of the A-8000 to the actual antenna voltage.

8-2-7 ANTENNA FACTOR

DAMAGE TO THE A-8000 IS POSSIBLE DURING CONDUCTED EMISSION MEASUREMENTS WHEN SWITCHING LISN LINES CONNECTED TO THE A-8000. CHECK THE UNIT SPECIFICATIONS BEFORE CONNECTING IT TO THE A-8000 INPUT.

CAUTION

Figure 8-5 Line Impedance Stabilization Network (LISN)

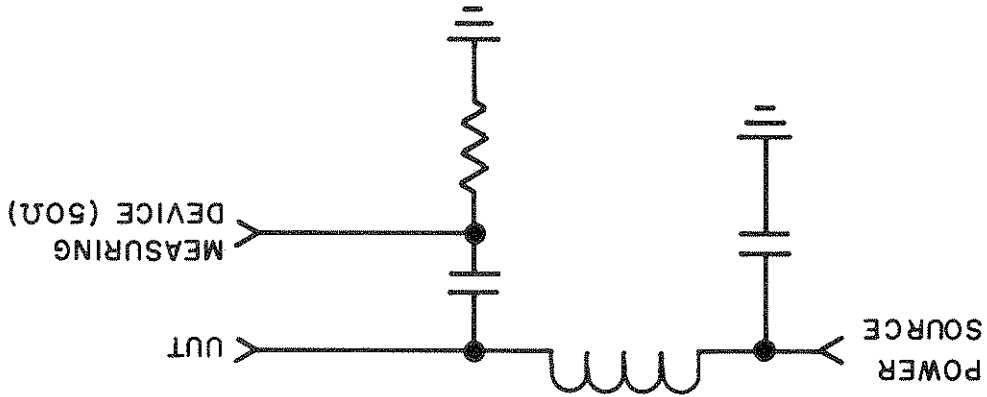

An LISN isolates power line EMI from the UT and measuring device, and prevents EMI from the UT from entering the power source. This provides isolation when making conducted EMI measurements (see figure 8-5).

8-2-6 LINE IMPEDANCE STABILIZATION NETWORKS (LISN)

Table 8-2 Quasi-Peak Time Constants

Time Constant	Charge Time (mSec)	Discharge Time (mSec)	Bandwidth (Hz)	Frequency Range
TC1	45	500	200	10 to 150 KHz
TC2	1	160	.9k	150 KHz to 30 MHz
TC3	1	550	120k	30 MHz to 1 GHz

EMI measurements are performed within the constraints stated in Table 8-2. The Charge Time Constant is the time required, after instantaneous application of a constant RF sine-wave (CW) voltage at the Analyzer Input, for the output voltage to reach 63 percent of its final value. The Discharge Time Constant is the time required, after instantaneous removal of a constant sine-wave (CW) voltage applied to the input of the measuring set, for the output voltage to fall to 37 percent of its initial value.

8-2-5 TIME CONSTANTS

8-3 QUASI-PEAK MEASUREMENT PROCEDURE

The following procedure is an example of one way to isolate signals and take Quasi-Peak readings. The advantages of this procedure include:

- Observing the entire A-8000 frequency range at one time;
- Eliminating ambient signals before introducing signals from the UUT;
- Eliminating the need to perform Quasi-Peak testing at all frequencies.

NOTE

While the following procedure for measuring Quasi-Peak is optional, the following guidelines are not:

- Always set the Amplitude Scale to LINEAR before making Quasi-Peak measurements.
- Set SCANWIDTH TO 0 KHZ/DIV (except as noted in Paragraphs 8-2-3 and 8-2-4).
- Use the dBV Reference Scale (optional).

Also, to "zero in" at the signal in question, use the IF GAIN and RF ATEN keys. Be cautious, however, to avoid introducing signal compression when adjusting IF GAIN.

1. Turn on the A-8000 with the UUT turned off. Set it to a Center Frequency of 500.0 MHz and a Scan Width of 100.0 MHz/Div (Press "RF" "500.0" "ENTER"). See Figure 8-6. This allows you to observe the full range of signals necessary for EMI measurements.

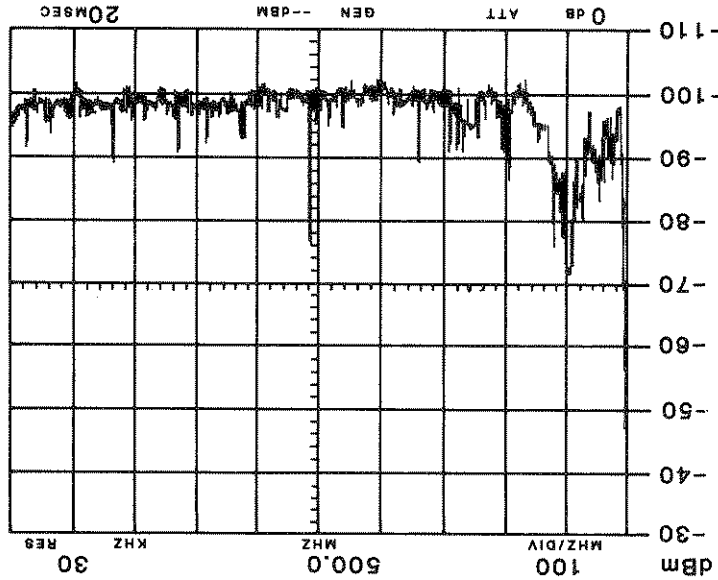
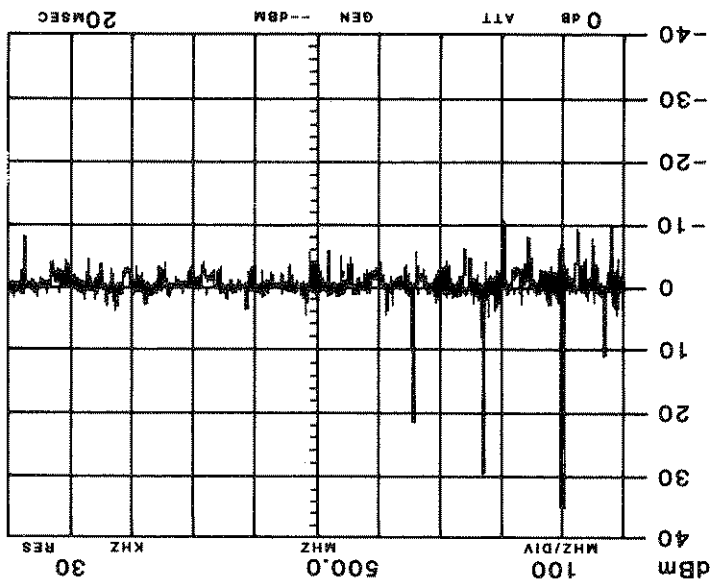

Figure 8-6 Initial Background or Ambient Signals

Figure 8-8 Reference Display with UUT Turned On



4. Turn on the unit to be tested for EMI. Watch for signals which appear when UUT is turned on. Note, in Figure 8-8, the signal at 100 MHz, 225 MHz and 330 MHz as a comparison to the signal in Figure 8-7. These signals are from UUT.

Figure 8-7 Reference Display with Ambient Signals Zeroed

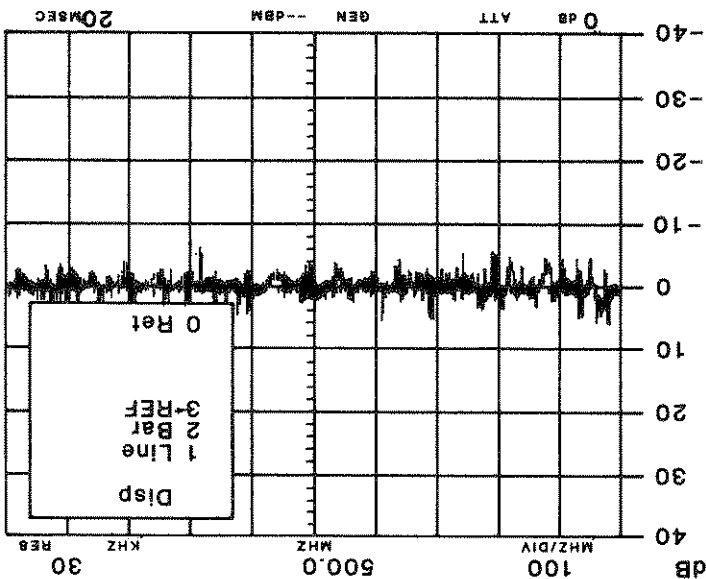

3. Enter the Display Menu (Press: "1") and select the REF display (Press: "3"). See Figure 8-7.
2. Enter MODE Menu (Press: "MENU" "2") and select LIVE (Press: "5"). Store the trace (Press: "3"). Exit MODE Menu (Press: "0").

The maximum EMI level for any electronic computing device is established by the FCC in Rules and Regulations, Volume II, Part 15, Subpart J.

NOTE

signal is within regulation at this point (i.e., at peak reading), then UUT passes and no further measurements are required (see Figure 8-10).

(Press: "MENU" "5" (Setup) "2" "2"). If the

7. Change the Reference Scale to Linear Mode (Press: LOG/LIN (Up or Down) and change the reference units to dBV.

Figure 8-9 Signal of Interest at 100 MHz

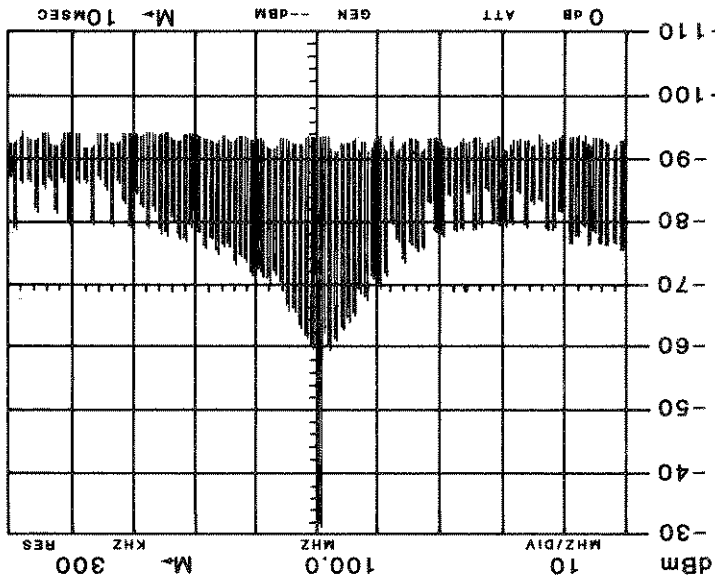

6. Use the IF GAIN and/or the RF ATTN keys to position the signal with its peak close to, but not above, the top graticule (see Figure 8-9).

Bandpass the frequency range in question, if signals in other bands are high.

NOTE

"MENU" "2" (display mode) "1" (line display) "RF" "100." "ENTER"

5. As an example, to look closer at the signal at 100 MHz, press the following key sequence:

Figure 8-11 Frequency in Question Before Quasi-Peak

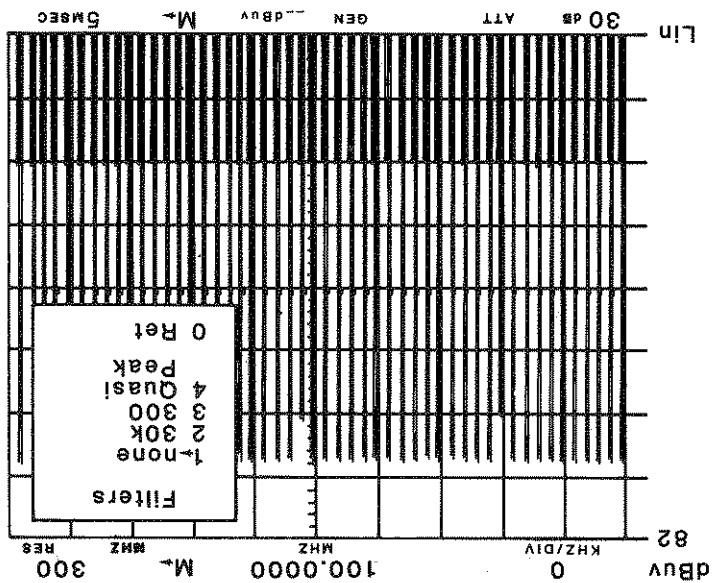

8. Use the SCAN WIDTH DOWN "←" key to set the Scan Width to zero. Return to the Master Menu and select the FILTERS Menu (press: "0" "4" "←"). See Figure 8-11.

Figure 8-10 UUT Readout in Linear Mode

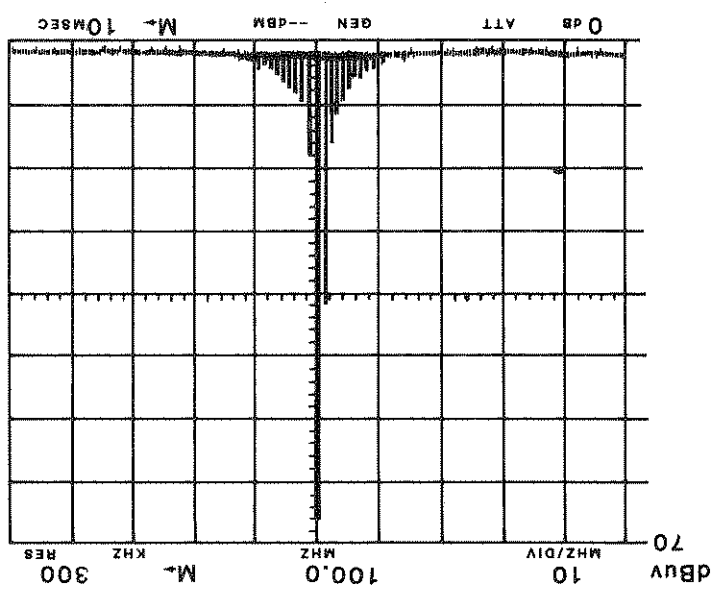
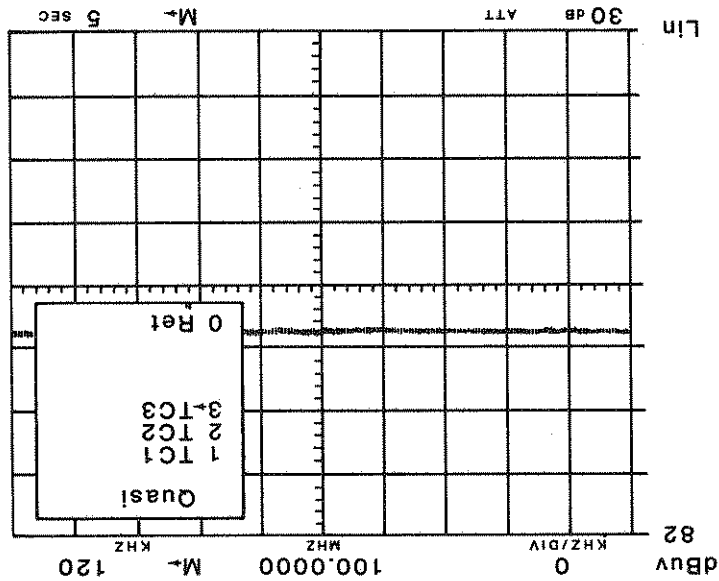

Figure 8-12 Frequency in Question with Quasi-Peak Activated



Be sure you have selected the correct time constant for the frequency in question. In Figure 8-12, the Signal Amplitude level is approximately 4.85 divisions above the bottom graticule on the display. The X value, from Table C-1, is -4.35. The Top of Scale is 82 dBu. Using the equation for Signal Amplitude ($A = T + X$), the calculated Signal Amplitude is 77.65 dBu. The actual Signal Amplitude is figured by computing the calculated Signal Amplitude with the Antenna Factor supplied by the manufacturer of the antenna. The adjusted Signal Amplitude value is then compared to the limit set by the FCC for EMI emissions for the UUT.

NOTE

9. Select the Quasi-Peak Filter Menu (Press: "4"). Refer to Figure 8-12 and to Appendix C to compute the Signal Amplitude at the frequency in question.

APPENDICES

APPENDIX A - A-8000 PERFORMANCE SPECIFICATIONS (SN 1300 & ON)

A-1 FREQUENCY

Tunable Frequency Range: 0 Hz to 2.5 GHz: Tunable in 100 Hz steps.
Frequency Span Width: 1 kHz/Div to 200 MHz/Div in 1-2-5 sequence, plus zero Scan, 250 MHz/Div and Full Scan.
Frequency Display Linearity: <5% of the indicated frequency separation.
Center Frequency Readout Accuracy: 3% of frequency display span plus Center Frequency X (0.5 x 10⁻⁶ plus Aging) with internal time base.
Resolution: 300 Hz, 3 kHz, 30 kHz and 300 kHz.
Bandwidth Ranges @3 dB: 300 Hz, 3 kHz, 30 kHz and 300 kHz.
@6 dB: 300 Hz, 3 kHz, 30 kHz and 300 kHz.
Accuracy: 30% of bandwidth selected.
Filter Shape Factor: 60 dB/3 dB ratio: 1 except 300 Hz bandwidth <12:1.
Sweep Rate: 5 ms/Div to 10 sec/Div in 1-2-5 sequence.
Video Filter: 30 kHz and 300 Hz bandwidths, selectable.
Display Bandwidth: 4 kHz
Video Output Bandwidth: 1 MHz
Residual FM: <200 Hz p-p at Scan Width settings below 200 kHz/Div.
Noise Sidebands (3 kHz Resolution Bandwidth): <-65 dBc @ 10X resolution bandwidth setting from CW signal (with 300 Hz Video Filter).
At 100 MHz, noise sidebands will increase from -65 dBc at a rate of .2 dB/100 MHz.

A-2 AMPLITUDE

Frequency Range: 100 kHz to 2.5 GHz.
Measurement Range: -120 dbm to +30 dbm.

Spurious: With an input signal ≥ 3 MHz at ≤ -30 dbm, the following spurious levels will be allowed at the following bands:

- 75 dbm max. from 10 kHz to 100 kHz;
- 85 dbm max. from 100 kHz to 1 MHz;
- 115 dbm max. from 1 MHz to 2 MHz.

Displayed Dynamic Range:

- 70 dB in 10 dB/Div Log Scale;
- 16 dB in 2 dB/Div log scale;
- 8 divisions with linear amplitude scale.

Amplitude Units:

dbm, dbv, dbmv, dbµv, dbµw.

Third Order Intermodulation Products:

<70 dbc for two signals displayed 10 db down from top reference level.

Amplitude Scale Linearity:

10 dB/Div log: ± 0.15 dB/db, but not more than ± 2.5 db over 70 db dynamic range.
 2 dB/Div log: ± 0.4 dB/2 db, but not more than ± 1.5 db over upper 14 db dynamic range.

Linear: Demodulation linearity less than 3% of full scale.

Frequency Response:

± 2.0 db with 10 db RF Attenuation.
 ± 1 db (± 2 db for 300 Hz RBW).

Bandwidth Switching Error:

IF Gain:

Range:

0 to 65 db in 1 db steps.
 ± 2 db from 0 to +20 db.
 ± 4 db from +20 to +65 db.

Accuracy:

A-3 INPUT

Impedance: 50Ω nominal, 75Ω (optional).
Attenuator: 60 dB range in 10 dB steps. (± 0.5 dB/10 dB step to a maximum of ± 2 dB.)
Maximum Input Levels: 4 VDC or +30 dBm with 60 dB input attenuation. +20 dBm for all other conditions.

A-4 OUTPUT

Calibrator:

Frequency: 100 MHz.

Accuracy: See Time Base.

Amplitude: -30 dBm, ± 1 dB.

Sweep Out: 0 to 5V ramp (nominal) into 1 MΩ.

Video Out: 800 mV peak into 1 MΩ.

Pen Lift: Plotter pen lift signal or scope blanking. TTL level.

Time Base: 10 MHz.

Stability: 0.5 ppm

Aging: 3 ppm (first year), 1 ppm per year thereafter.

EXT Standard Input: 10 MHz @ +5 to +20 dBm.

A-5 GENERAL CHARACTERISTICS

Dimensions:

33.3 cm (13.1") wide, 18.5 cm (7.3") high, 49.8 cm (19.6") deep.

Weight (maximum): 16.8 kg (37 lbs.) without options.

Temperature Range: 0 to 50°C.

Power Requirements:

Line: 106 to 266 VAC, 50 to 400 Hz, 60 W typical @ 115 VAC (no options).

- A-6 TRACKING GENERATOR (OPTION)**

External D.C.: 12 to 30 VDC nominal, 4.5 Amps @ 12V
 typical (no options), 2 Amps @ 28V
 typical (no options).

Frequency Range: 100 KHz to 2.5 GHz.

Output Level: 0 dbm to -75 dbm in 1 db steps.

Attenuator Accuracy: \pm (0.5 db + 0.5 db/10 db); \pm 2 db max

Residual FM: <200 Hz peak-to-peak

Output Flatness: \pm 2 db

Output Impedance: 50 Ω nominal

Spurious: Harmonics: 20 dbc or lower,
 Non-harmonics: 30 dbc or lower.

A-7 IEEE 488 INTERFACE (GPIB) (OPTION)

The A-8000 provides remote communication via the General Purpose Interface Bus (GPIB). This conforms to IEEE Standard 488-1978. The A-8000 performs to the following IEEE Standard 488-1978 Subsets: SH1, AH1, T6, TE0, LA, LE0, SR1, RL2, PP0, DC1, DT1 and CO.

A-8 20 DB AMPLIFIER (OPTION)

Frequency Range: 10 MHz to 1.0 GHz

Gain: 20 dbm (+2, -4 db)

A-9 BATTERY (OPTION)

Battery Type: 12V, 5 ampere-hour rechargeable

Battery Operation: 30 minutes between charges

A-10 RECEIVER (OPTION)

Range: 100 KHz to 2.5 GHz

Center Frequency Resolution: 100 Hz

Sensitivity: 2 μ V typical

Pin Number	Control Line	Direction
1, 7	GROUND	---
2	TRANSMIT (TX) DATA	(Output)
3	RECEIVE (RX) DATA	(Input)
4	RTS	(Output)
5	CTS	(Input)
6	DSR	(Input)
8	DCD	(Input)
20	DTR	(Output)

The A-800 provides remote communication by a half-duplex RS-232C type bus. An external controller configured to RS-232C operation is required. The A-800 becomes a slave to the external controller.

A-12 RS-232C INTERFACE (OPTION)

Frequency Range	Bandwidth	Time Constant	Charge Time (ms)	Discharge Time (ms)
10 KHZ to 150 KHZ	200 Hz	TC1	45	500
150 KHZ to 30 MHZ	9 KHZ	TC2	1	160
30 MHZ to 1 GHz	120 KHZ	TC3	1	550

A-11 QUASI-PEAK DETECTOR (OPTION)

Mode	Nominal Receiver Bandwidth	Receiver Bandwidth (at 3 dB)	Down at 40 dB	Adjacent Channel Rejection:
FM2	200 KHZ	200 KHZ	300 KHZ	27 KHZ
FM1	15 KHZ	15 KHZ	12 KHZ	6 KHZ
SSB	6 KHZ	6 KHZ	12 KHZ	6 KHZ
AM1	6 KHZ	6 KHZ	12 KHZ	6 KHZ
AM2	15 KHZ	6 KHZ	12 KHZ	15 KHZ

down) (-35 dB)

Selectivity (at 3 dB):

A-13 50Ω/75Ω ADAPTER (OPTION)

Connector Type: BNC or Type F

Frequency Range: 0.1 MHz to 1000 MHz

APPENDIX B - CAPTURING A-8000 ANALYZER TRACES

B-1 GENERAL

The A-8000 Spectrum Analyzer is controlled by multiple microprocessors which direct the activity between its various subsystems. This allows a microprocessor to dedicate itself to a single task, such as processing the Remote Programming Language. The A-8000 Spectrum Analyzer accomplishes remote control via either the IEEE 488-1978 Bus or the RS-232C Interface option (both options cannot be on one unit). The A-8000 remote control simulates keyboard control, as close as possible, to write and store traces.

B-2 WRITING AND STORING TRACES

The A-8000 analyzer display is a visual representation of the digitized samples taken by the analyzer's sampler subsystem. This display is organized horizontally into 390 points. The amplitude for each point has a value from 0 to 479 from the analyzer base line to the top of the display window. Each sample point represents the actual frequency and amplitude level of the signal being digitized. (The value returned can be negative or as high as 600 to accommodate actual stored "REF" signal ratios.) Each point is computed using the following relationships:

Horizontal Unit Value = Scanwidth/39

Vertical Unit Value = (Scale * 8) / 479

Top of Screen = RF ATEN - IF GAIN + BIAS

BIAS = -30 for dbm reference

= 20 for dbmV reference

= 80 for dbmV reference

Bottom of Screen = Top of Screen - Scale * 8

Left-hand Frequency = Center Frequency - Scanwidth * 5

Right-hand Frequency = Center Frequency + Scanwidth * 5

The following commands are used to compute and return these values:

- RFATTN? - Returns RF Attenuation value
- IFGAIN? - Returns IF GAIN value
- SCALE? - Returns 10, 2 or LINEAR
- REF? - Returns the Center Frequency
- SCANW? - Returns the Scanwidth setting
- REF? - Returns the Reference Scale (DBM, DBUW, DBV, DBMW or DBUV)

The order in which these two commands are entered, in this context, is unimportant.

NOTE

MODE=RECALL

View the stored segment by entering the Remote Command:

PUT(20)=101:104:105:110:120:121:122:122:122:123

Group 20, above, could be returned to the stored area of the A-8000 by entering the Remote Command:

EXAMPLE

This would be the stored values for an area near Center Frequency. To request an entire display, 39 individual GET(XX)? Commands must be requested from the analyzer.

101:104:105:110:120:121:122:122:122:123

The response to this request might be:

GET(20)?

command:

To return group 20 (horizontal points 200 through 209), enter the

EXAMPLE

The screen is divided into 39 horizontal groups of 10 points, which allows segments of the screen to be returned as the entire display may not be required for every user application of the A-8000. The GET(XX)? Command returns a maximum of 42 characters, including a carriage return and linefeed control characters. This line length is easily accepted by most compatible controllers and permits any of the 39 groups of ten sample points to be requested.

Where XX is a value from 1 to 39.

GET(XX)?

the Remote Command:

When the screen is stored, groups of ten points can be requested using

MODE=STORE

Before a display can be returned to a host controller, the display must be stored. To store the display, use the Remote Command:

B-4 PROGRAMMING EXAMPLES

Communication between an external controller and the A-8000 requires some command and request subroutines to be written for either the IEEE 488-1978 or RS-232 I/O ports. Using standard BASIC programming language routines, these are accomplished with INPUT and PRINT statements. Sample BASIC routines are given on the following pages for communications with the IBM[™] Personal Computer (and compatible units) and a Hewlett-Packard[™] model 85.

B-4-1 BASIC SUBROUTINES FOR COMMUNICATING WITH AN IBM-PC[™].

To communicate with an RS-232 port, the following subroutine can be used:

```
REM 1000
REM RS-232 RECEIVE ROUTINE
REM RETURNS ASCII STRING IN IN$
REM
REM OPEN "COM1:9600,N,8,2CD,DS" AD #1
REM INPUT #1,IN$
RETURN
```

```
REM 2000
REM RS-232 OUTPUT ROUTINE
REM SHIP ASCII STRING CONTAINED IN SEND$
REM PRINT #1,SEND$
RETURN
```

To communicate with an IEEE 488-1978 port, the following subroutine can be used:

```
REM 1000
REM IEEE-488 RECEIVE ROUTINE
REM ADDR$ = IEEE ADDRESS ON ENTRY
REM IN$=SPACE$(50)
CALL RECVST(ADR$,IN$)
RETURN
```

```
REM 2000
REM IEEE-488 TRANSMIT ROUTINE
REM ADDR$ = IEEE ADDRESS ON ENTRY
REM SEND$ = COMMAND STRING
REM SEND$=SEND$+CHR$(10)
CALL SENDST(ADR$,SEND$)
RETURN
```

CNT% = 0

REM
REM -- (PARSE THE INPUT PARAMETERS) --
REM 3000

The following subroutines are called from the above routine.

```

RETURN
MHZDOT = (SCAN2*10)/390
RFF = RFF + (SCANW * 5)
LRF = RFF - (SCANW * 5)
DBD10 = (SCALE% * 8) / 479
BOT% = TOP% - (SCALE% * 8)
TOP% = -30 + (RFATN% - IFGAIN%) ' ASSUME DMB REFERENCE
SCANW = VAL(IN$(5))
RFF = VAL(IN$(4))
SCALE% = VAL(IN$(3))
IFGAIN% = VAL(IN$(2))
RFATN% = VAL(IN$(1))
GOSUB 3000 ' PARSE DATA INTO IN$( )
GOSUB 1000 ' RECEIVE DATA
GOSUB 2000 ' SEND DATA
SEND$="RFATN?IFGAIN?SCALE?RFF?SCANW?"
REM
REM --- ( GET SCREEN PARAMETERS ) ---
REM 5000

```

When the appropriate input and output routines have been written and fully tested, the parameters for the A-800 can be requested per the following subroutine:

B-4-3 BASIC SUBROUTINE TO REQUEST PARAMETERS

```

RETURN
OUTPUT N,$$
REM
REM IEEE-488 OUTPUT ROUTINE
REM 2000

```

```

RETURN
ENTER N,$
REM
REM IEEE-488 INPUT ROUTINE
REM 1000

```

To communicate with an HP-85™ through the IEEE-488 port, the following subroutine can be used:

B-4-2 BASIC SUBROUTINE FOR COMMUNICATING WITH A HEWLETT-PACKARD™ MODEL 85

All 390 sample points in this example are stored as integers in the array DOT%. Using the known scaling factors for the analyzer environment, these points can be translated into actual Reference Scale and Frequency units.

Similar routines can be written for the controller being used locally. Routines can also be translated into PASCAL, "C" or FORTRAN, depending on the preferred language of the local controller.

```

7000 REM
REM ( GET SCREEN OF DATA DOTS ( 0 - 389 ) )
SEND$ = "MODE=STORE"
GOSUB 2000
ELEM% = 1
FOR SLOOP1% = 1 TO 39
  REQUEST ALL 39 GROUPS
  SEND$ = "GET("+MID$(STR$(SLOOP1%),2)+"?)" ' BUILD REQUEST
  GOSUB 2000
  SEND DATA
  GOSUB 1000
  RECEIVE DATA
  FOR SLOOP2% = 1 TO 9
    DOT%(ELEM%) = VAL(IN$) ' CONVERT STRING TO INTEGER
    IN$ = MID$(IN$, INSTR(IN$, ":" )+1) ' PARSE OVER COLONS
    ELEM% = ELEM% + 1
  NEXT SLOOP 1%
RETURN

```

The following subroutine can be used to send parameters to the A-8000 and subsequently, read the A-8000 display.

B-4-4 BASIC SUBROUTINE TO SEND PARAMETERS

```

3100 POSN%=INSTR(IN$, ":") ' PARAMETERS ARE SEPARATED BY COLONS
IF(POSN% = 0) THEN 3200
CNT% = CNT%+1
IN$(CNT%) = LEFT$(IN$, POSN%-1)
IN$=MID$(IN$, POSN%+1)
GOTO 3100
3200 DNT% = CNT%+1
IN$(CNT%)=IN$
RETURN

```

APPENDIX C - A-8000 SIGNAL AMPLITUDE VALUES IN LINEAR MODE

Table C-1 contains values calculated for measuring Signal Amplitudes in linear mode, in .05 division intervals. Table C-1 values for X are computed from the formula: $X = 20 \log (D \div 8)$; and are applied to the following formula to compute the Signal Amplitude (A): $A = T + X$.

T is the Top of Screen value in dbm, dbmV, dBV, dBmV or dBuV. D is the number of divisions from the bottom graticule of the screen.

8.00	Div	X	6.00	Div	X	4.00	Div	X	2.00	Div	X
7.95		0.05	5.95		-2.57	3.95		-6.13	1.95		-12.04
7.90		-0.11	5.90		-2.64	3.90		-6.24	1.90		-12.49
7.85		-0.16	5.85		-2.72	3.85		-6.35	1.85		-12.72
7.80		-0.22	5.80		-2.79	3.80		-6.47	1.80		-12.96
7.75		-0.28	5.75		-2.87	3.75		-6.58	1.75		-13.20
7.70		-0.33	5.70		-2.94	3.70		-6.70	1.70		-13.45
7.65		-0.39	5.65		-3.02	3.65		-6.82	1.65		-13.71
7.60		-0.45	5.60		-3.10	3.60		-6.94	1.60		-13.98
7.55		-0.50	5.55		-3.18	3.55		-7.06	1.55		-14.26
7.50		-0.56	5.50		-3.25	3.50		-7.18	1.50		-14.54
7.45		-0.62	5.45		-3.33	3.45		-7.31	1.45		-14.83
7.40		-0.68	5.40		-3.41	3.40		-7.43	1.40		-15.14
7.35		-0.74	5.35		-3.49	3.35		-7.56	1.35		-15.46
7.30		-0.80	5.30		-3.58	3.30		-7.69	1.30		-15.78
7.25		-0.86	5.25		-3.66	3.25		-7.82	1.25		-16.12
7.20		-0.92	5.20		-3.74	3.20		-7.96	1.20		-16.48
7.15		-0.98	5.15		-3.83	3.15		-8.10	1.15		-16.85
7.10		-1.04	5.10		-3.91	3.10		-8.23	1.10		-17.23
7.05		-1.10	5.05		-4.00	3.05		-8.38	1.05		-17.64
7.00		-1.16	5.00		-4.08	3.00		-8.52	1.00		-18.06
6.95		-1.22	4.95		-4.17	2.95		-8.67	0.95		-18.51
6.90		-1.28	4.90		-4.26	2.90		-8.81	0.90		-18.98
6.85		-1.35	4.85		-4.35	2.85		-8.96	0.85		-19.47
6.80		-1.41	4.80		-4.44	2.80		-9.12	0.80		-20.00
6.75		-1.48	4.75		-4.53	2.75		-9.28	0.75		-20.56
6.70		-1.54	4.70		-4.62	2.70		-9.43	0.70		-21.16
6.65		-1.61	4.65		-4.71	2.65		-9.60	0.65		-21.80
6.60		-1.67	4.60		-4.81	2.60		-9.76	0.60		-22.50
6.55		-1.74	4.55		-4.90	2.55		-9.93	0.55		-23.25
6.50		-1.80	4.50		-5.00	2.50		-10.10	0.50		-24.08
6.45		-1.87	4.45		-5.09	2.45		-10.28	0.45		-25.00
6.40		-1.94	4.40		-5.19	2.40		-10.46	0.40		-26.02
6.35		-2.01	4.35		-5.29	2.35		-10.64	0.35		-27.18
6.30		-2.07	4.30		-5.39	2.30		-10.83	0.30		-28.52
6.25		-2.14	4.25		-5.49	2.25		-11.02	0.25		-30.10
6.20		-2.21	4.20		-5.60	2.20		-11.21	0.20		-32.04
6.15		-2.28	4.15		-5.70	2.15		-11.41	0.15		-34.54
6.10		-2.36	4.10		-5.81	2.10		-11.62	0.10		-38.06
6.05		-2.43	4.05		-5.91	2.05		-11.83	0.05		-44.08
									0.01		-58.06

Table C-1 A-8000 Signal Amplitude (A) Values for $X = 20 \log (D \div 8)$

Spectrum Analyzers with microprocessors may automatically select optimum resolution bandwidths based on scan width selection. The scan width determines the frequency spectrum displayed on the spectrum analyzer CRT. If the resolution bandwidth is too wide for the scan width selected (Figure D-2), the ability to distinguish individual spectral components is lost. Notice, by changing only the resolution bandwidth parameter in Figure D-3, these spectral components become distinguishable. One of several bandwidth filters can be selected for most scan width or sweep rate settings. A usual resolution bandwidth is greater than 1/50th the scan width selection, where possible. The capability to select these functions automatically or individually is a typical function of most spectrum analyzers (see Appendix E).

1. Resolution Bandwidth = 30 KHz
Scan Width = 500 KHz/DIV
2. Resolution Bandwidth = 30 KHz
Scan Width = 50 KHz/DIV

following settings:

EXAMPLE: Note the difference in the shape of the signal display at the

The resolution bandwidth gives the capacity to resolve spectral lines. The smaller the bandwidth, the greater the analyzer's ability to detect closely spaced lines. The signal and the shape of the resolution bandwidth filter determine the shape of the signal displayed on the CRT.

Figure D-1 Determining the Resolution Bandwidth on Filter Response Curve

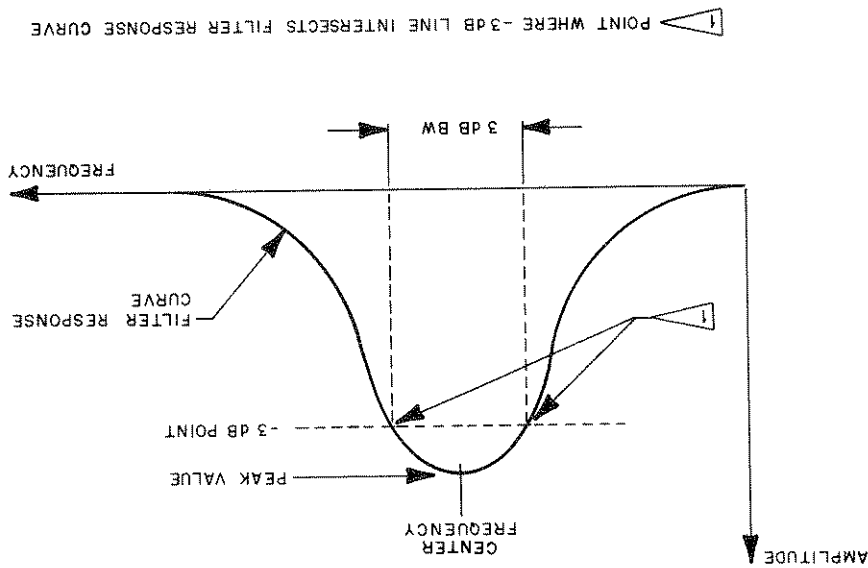

Resolution Bandwidth is the width in Hertz (Hz), of a spectrum analyzer's response to a Continuous Wave (CW) signal. This width is the frequency difference at specific points on the response curve (see Figure D-1). The points are either 3 or 6 dB down from peak.

APPENDIX D - RESOLUTION BANDWIDTH

As the bandwidth becomes narrower, the sweep rate needs to be slower. This allows the signal to trace the correct amplitude through the filter.

NOTE

Figure D-4 Composite of Figures D-2 and D-3

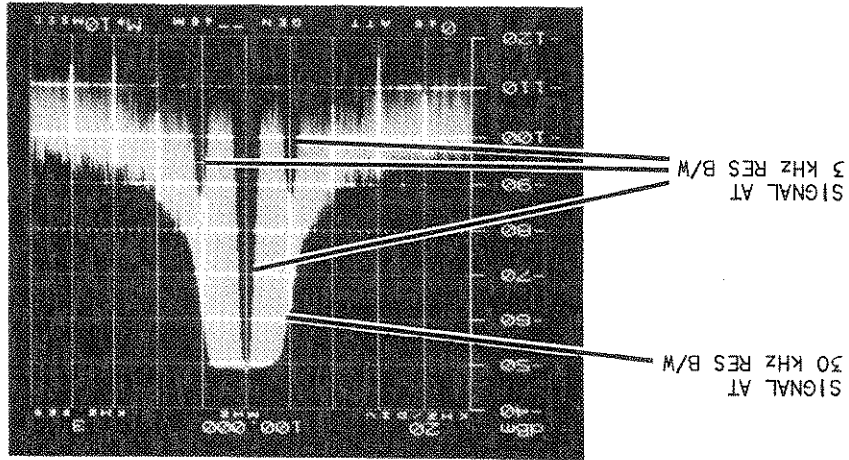

By selecting a narrower resolution bandwidth, the bandwidth is normally reduced by a factor of 10 and the noise floor drops 10 dB. The combination of these occurrences allows signals to become visible and prominent. Figure D-4 is a composite of figure D-2 and figure D-3.

Figure D-3 Reset Resolution Bandwidth to 3 KHZ (20 KHZ Sidebands Visible)

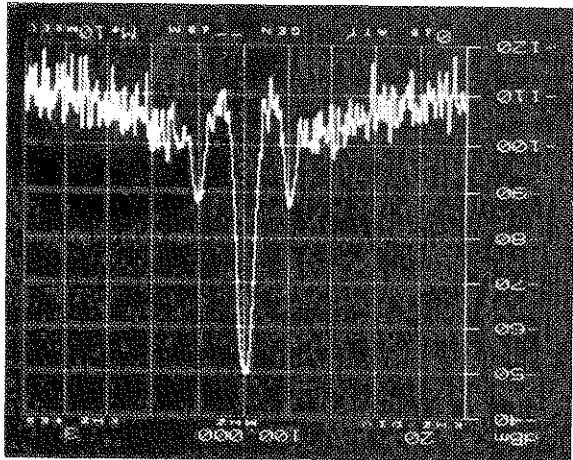

Figure D-2 Resolution Bandwidth Setting 30 KHZ (20 KHZ Sidebands Not Visible)

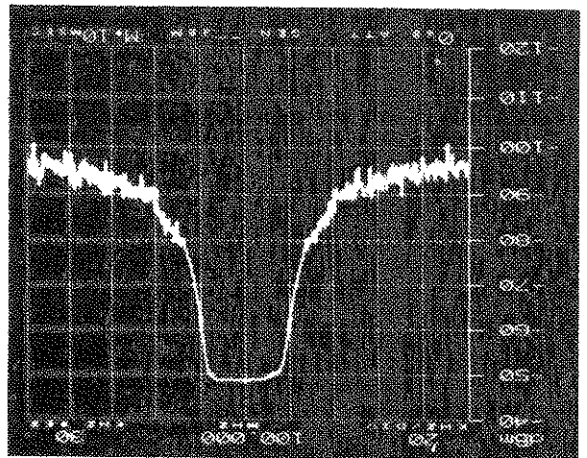

Figure D-6 Reducing Bandwidth Drops Noise Floor to Show Signals

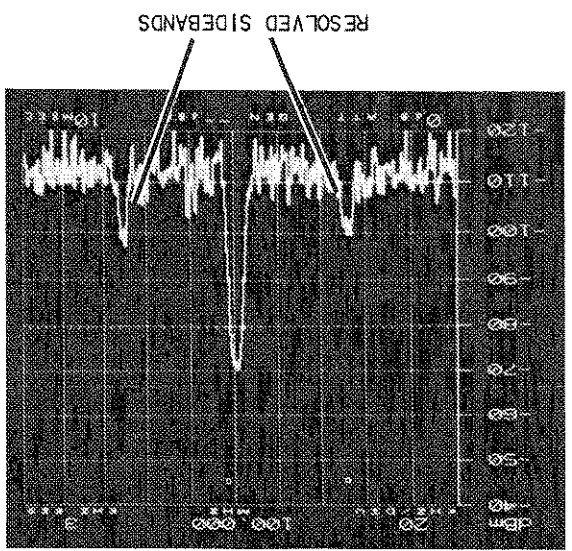
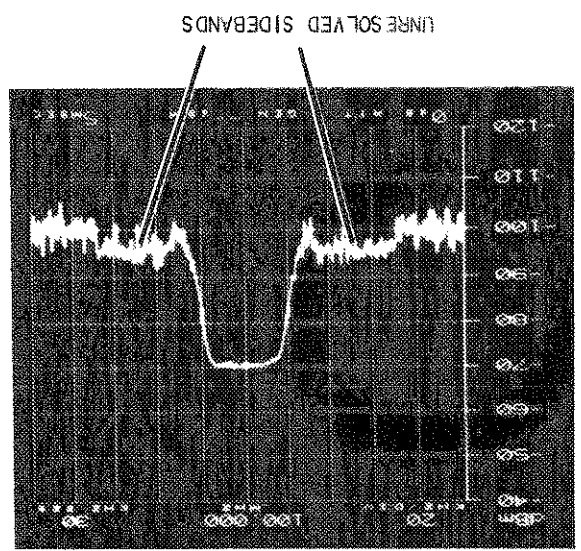

Figure D-5 Obstructed Signal Due to Noise Floor



In some instances, low-level signals may be obstructed by the level of the noise floor (Figure D-5). Selecting a narrower resolution bandwidth causes the noise floor to drop, which allows obstructed signals to appear (Figure D-6).

APPENDIX E - OPTIMIZATION OF RESOLUTION BANDWIDTHS

AND SWEEP RATES

Optimization allows the A-8000 to automatically select optimal Resolution Bandwidth and Sweep Rate for most Scan Width settings. The settings are based upon the behavior of the A-8000 Spectrum Analyzer. When active, the Scan Width setting determines the Resolution Bandwidth setting. The combination of the Center Frequency, the Scan Width and Resolution Bandwidth settings determine the Sweep Rate setting.

E-1 BANDWIDTH OPTIMIZATION

When Bandwidth Optimization is active, changing the Scan Width changes the Resolution Bandwidth per Table E-1. The Resolution Bandwidth can be reset to any of the available values on the A-8000.

SCAN WIDTH	RES B/W
0 KHz/DIV	300 Hz
1 KHz/DIV	300 Hz
2 KHz/DIV	300 Hz
5 KHz/DIV	3 KHz
10 KHz/DIV	3 KHz
20 KHz/DIV	3 KHz
50 KHz/DIV	30 KHz
100 KHz/DIV	30 KHz
200 KHz/DIV	30 KHz
500 KHz/DIV	30 KHz
1 MHz/DIV	300 KHz
2 MHz/DIV	300 KHz
5 MHz/DIV	300 KHz
10 MHz/DIV	300 KHz
20 MHz/DIV	3 MHz
50 MHz/DIV	3 MHz
100 MHz/DIV	3 MHz
200 MHz/DIV	3 MHz
250 MHz/DIV	3 MHz

Table E-1 Optimal Resolution Bandwidth Settings

E-2 SWEEP RATE OPTIMIZATION

When Sweep Rate Optimization is active, the Sweep Rate may change when any of the following conditions occur:

- The Scan Width is changed.
- The Resolution Bandwidth is changed.
- The Center Frequency is changed.

Table E-2 shows optimized Sweep Rate settings without video filtering. The Sweep Rates may be reset to any slower value. If a faster value is selected, an "UNCAL" condition occurs. The Uncal condition occurs because the Sweep rate is set too fast to accurately measure signal amplitudes or if too much RF is passed through the filters.

Table E-3 shows optimized Sweep rate settings with the 300 Hz Video Filter turned on. As in Table E-2, Sweep Rates may be reset to any slower value than the optimized setting. Faster Sweep Rate settings result in an "UNCAL" condition.

"UNCAL" should now appear in the upper-left corner of the CRT instead of the graticule unit. Increase the Sweep Rate value until the "UNCAL" message is replaced by the graticule units. This is the fastest sweep rate setting that should be selected for measurements on the A-8000 using the specified Scan Width and Sweep Rate settings. (Find this value on Table E-2.)

Scan Width = 500 KHZ/DIV
 Res B/W = 3 KHZ
 Sweep Rate = 10 msec/DIV

EXAMPLE: Select the following:

Table E-2 Sweep Rate Optimization With No Video Filter

BANDWIDTH	300 HZ	3 KHZ	30 KHZ	300 KHZ	3 MHZ
SCAN WIDTH	5 msec	5 msec	5 msec	5 msec	5 msec
0 KHZ/DIV	5 msec	5 msec	5 msec	5 msec	5 msec
1 KHZ/DIV	10 msec	5 msec	5 msec	5 msec	5 msec
2 KHZ/DIV	20 msec	5 msec	5 msec	5 msec	5 msec
5 KHZ/DIV	50 msec	5 msec	5 msec	5 msec	5 msec
10 KHZ/DIV	.1 SEC	5 msec	5 msec	5 msec	5 msec
20 KHZ/DIV	.2 SEC	5 msec	5 msec	5 msec	5 msec
50 KHZ/DIV	1 SEC	5 msec	5 msec	5 msec	5 msec
100 KHZ/DIV	2 SEC	5 msec	5 msec	5 msec	5 msec
200 KHZ/DIV	UNCAL	10 msec	5 msec	5 msec	5 msec
500 KHZ/DIV	UNCAL	20 msec	5 msec	5 msec	5 msec
1 MHZ/DIV	UNCAL	.1 SEC	50 msec	5 msec	5 msec
2 MHZ/DIV	UNCAL	.5 SEC	UNCAL	5 msec	5 msec
5 MHZ/DIV	UNCAL	1 SEC	UNCAL	5 msec	5 msec
10 MHZ/DIV	UNCAL	UNCAL	.5 SEC	10 msec	5 msec
20 MHZ/DIV	UNCAL	UNCAL	2 SEC	20 msec	5 msec
50 MHZ/DIV	UNCAL	UNCAL	UNCAL	50 msec	5 msec
100 MHZ/DIV	UNCAL	UNCAL	UNCAL	UNCAL	10 msec
200 MHZ/DIV	UNCAL	UNCAL	UNCAL	UNCAL	20 msec
250 MHZ/DIV	UNCAL	UNCAL	UNCAL	UNCAL	20 msec
FULL (265 MHZ/DIV)	UNCAL	UNCAL	UNCAL	UNCAL	20 msec

Table E-4 Sweep Rate Optimization with 30 KHz Video Filter

BANDWIDTH					
SCAN WIDTH	300 HZ	3 KHZ	30 KHZ	300 KHZ	3 MHZ
0 KHZ/DIV	5 mSEC	5 mSEC	5 mSEC	5 mSEC	5 mSEC
1 KHZ/DIV	10 mSEC	5 mSEC	5 mSEC	5 mSEC	5 mSEC
2 KHZ/DIV	20 mSEC	5 mSEC	5 mSEC	5 mSEC	5 mSEC
5 KHZ/DIV	.1 SEC	5 mSEC	5 mSEC	5 mSEC	5 mSEC
10 KHZ/DIV	.2 SEC	5 mSEC	5 mSEC	5 mSEC	5 mSEC
20 KHZ/DIV	.5 SEC	5 mSEC	5 mSEC	5 mSEC	5 mSEC
50 KHZ/DIV	1 SEC	5 mSEC	5 mSEC	5 mSEC	5 mSEC
100 KHZ/DIV	2 SEC	10 mSEC	5 mSEC	5 mSEC	5 mSEC
200 KHZ/DIV	UNCAL	.1 SEC	10 mSEC	5 mSEC	5 mSEC
500 KHZ/DIV	UNCAL	1 SEC	20 mSEC	5 mSEC	5 mSEC
1 MHZ/DIV	UNCAL	UNCAL	.1 SEC	5 mSEC	5 mSEC
2 MHZ/DIV	UNCAL	UNCAL	.5 SEC	5 mSEC	5 mSEC
5 MHZ/DIV	UNCAL	UNCAL	1 SEC	5 mSEC	5 mSEC
10 MHZ/DIV	UNCAL	UNCAL	.5 SEC	10 mSEC	5 mSEC
20 MHZ/DIV	UNCAL	UNCAL	UNCAL	20 mSEC	5 mSEC
50 MHZ/DIV	UNCAL	UNCAL	UNCAL	50 mSEC	10 mSEC
100 MHZ/DIV	UNCAL	UNCAL	UNCAL	UNCAL	20 mSEC
200 MHZ/DIV	UNCAL	UNCAL	UNCAL	UNCAL	50 mSEC
250 MHZ/DIV	UNCAL	UNCAL	UNCAL	UNCAL	.1 SEC
FULL (265 MHZ/DIV)	UNCAL	UNCAL	UNCAL	UNCAL	.5 SEC

Table E-4 shows optimized Sweep Rate settings with the 30 KHz Video Filter turned on. Again, Sweep Rates may be reset to any slower Sweep Rate value than the optimized setting. Faster Sweep Rate settings result in an "UNCAL" condition.

Table E-3 Sweep Rate Optimization with 300 HZ Video Filter

BANDWIDTH					
SCAN WIDTH	300 HZ	3 KHZ	30 KHZ	300 KHZ	3 MHZ
0 KHZ/DIV	5 mSEC	5 mSEC	5 mSEC	5 mSEC	5 mSEC
1 KHZ/DIV	10 mSEC	5 mSEC	5 mSEC	5 mSEC	5 mSEC
2 KHZ/DIV	20 mSEC	5 mSEC	5 mSEC	5 mSEC	5 mSEC
5 KHZ/DIV	.1 SEC	5 mSEC	5 mSEC	5 mSEC	5 mSEC
10 KHZ/DIV	.2 SEC	10 mSEC	5 mSEC	5 mSEC	5 mSEC
20 KHZ/DIV	.5 SEC	20 mSEC	5 mSEC	5 mSEC	5 mSEC
50 KHZ/DIV	1 SEC	50 mSEC	5 mSEC	5 mSEC	5 mSEC
100 KHZ/DIV	2 SEC	UNCAL	10 mSEC	5 mSEC	5 mSEC
200 KHZ/DIV	UNCAL	UNCAL	20 mSEC	5 mSEC	5 mSEC
500 KHZ/DIV	UNCAL	UNCAL	1 SEC	5 mSEC	5 mSEC
1 MHZ/DIV	UNCAL	UNCAL	.1 SEC	10 mSEC	5 mSEC
2 MHZ/DIV	UNCAL	UNCAL	.5 SEC	20 mSEC	5 mSEC
5 MHZ/DIV	UNCAL	UNCAL	1 SEC	50 mSEC	5 mSEC
10 MHZ/DIV	UNCAL	UNCAL	UNCAL	UNCAL	10 mSEC
20 MHZ/DIV	UNCAL	UNCAL	UNCAL	UNCAL	20 mSEC
50 MHZ/DIV	UNCAL	UNCAL	UNCAL	UNCAL	50 mSEC
100 MHZ/DIV	UNCAL	UNCAL	UNCAL	UNCAL	UNCAL
200 MHZ/DIV	UNCAL	UNCAL	UNCAL	UNCAL	UNCAL
250 MHZ/DIV	UNCAL	UNCAL	UNCAL	UNCAL	UNCAL
FULL (265 MHZ/DIV)	UNCAL	UNCAL	UNCAL	UNCAL	.5 SEC

Optimization can be turned on or off via menu operation. Both the Resolution Bandwidth and the Sweep Rate Optimization functions can be set independently, as described in Paragraph 4-9.

Turning off Resolution Bandwidth Optimization affects only Resolution Bandwidth settings. That is, changing the Scan Width does not cause the Resolution Bandwidth to change. The Sweep Rate setting may still change. If Resolution Bandwidth Optimization is turned off, "M+" appears in the upper right corner of the CRT display. The arrow points to the Resolution Bandwidth display. If optimization is turned on, this block is blank.

Turning off Sweep Rate Optimization affects only Sweep Rate settings. That is, changing either the Scan Width or the Resolution Bandwidth does not cause the Sweep Rate to change. If Sweep Rate Optimization is turned off, "M+" appears in the lower-right corner of the CRT display. The arrow points to the Sweep Rate display. If optimization is turned on, the block is blank.

If Resolution Bandwidth Optimization and Sweep Rate Optimization are both turned off, then changing the Scan Width affects neither the Resolution Bandwidth nor the Sweep Rate settings. Also, changing the Resolution Bandwidth has no effect on the Sweep Rate. The "M+" is displayed in both applicable blocks on the CRT.

APPENDIX F - REPACKING FOR SHIPMENT

F-1 SHIPPING INFORMATION

IFR test sets returned to factory for calibration, service or repair must be repackaged and shipped subject to the following conditions:

Do not return any products to factory without first receiving authorization from IFR Customer Service Department.

CONTACT: Customer Service Dept.
IFR Systems, Inc.
10200 West York Street
Wichita, Kansas 67215

Telephone: (800)-835-2350
TMX: 910-741-6952

All test sets must be tagged with:

- a. Owner's identification and address.
- b. Nature of service or repair required.
- c. Model No.
- d. Serial No.

Sets must be repackaged in original shipping containers using IFR packing models. If original shipping containers and materials are not available, contact IFR Customer Service Dept. for shipping instructions.

All freight costs on non-warranty shipments are assumed by customer. (See "Warranty Packet" for freight charge policy on warranty claims.)

F-2 REPACKING PROCEDURE (Reference - Figure F-1)

1. Make sure bottom packing mold is seated on floor of shipping container.
2. Carefully wrap test set with polyethylene sheeting to protect finish.
3. Place test set into shipping container, making sure set is securely seated in bottom packing mold.
4. Place top packing mold over top of set and press down until mold rests solidly on bottom packing mold.
5. Close shipping container lids and seal with shipping tape or an industrial stapler. Tie all sides of container with break-resistant rope, twine or equivalent.

Figure F-1 Repacking for Shipment

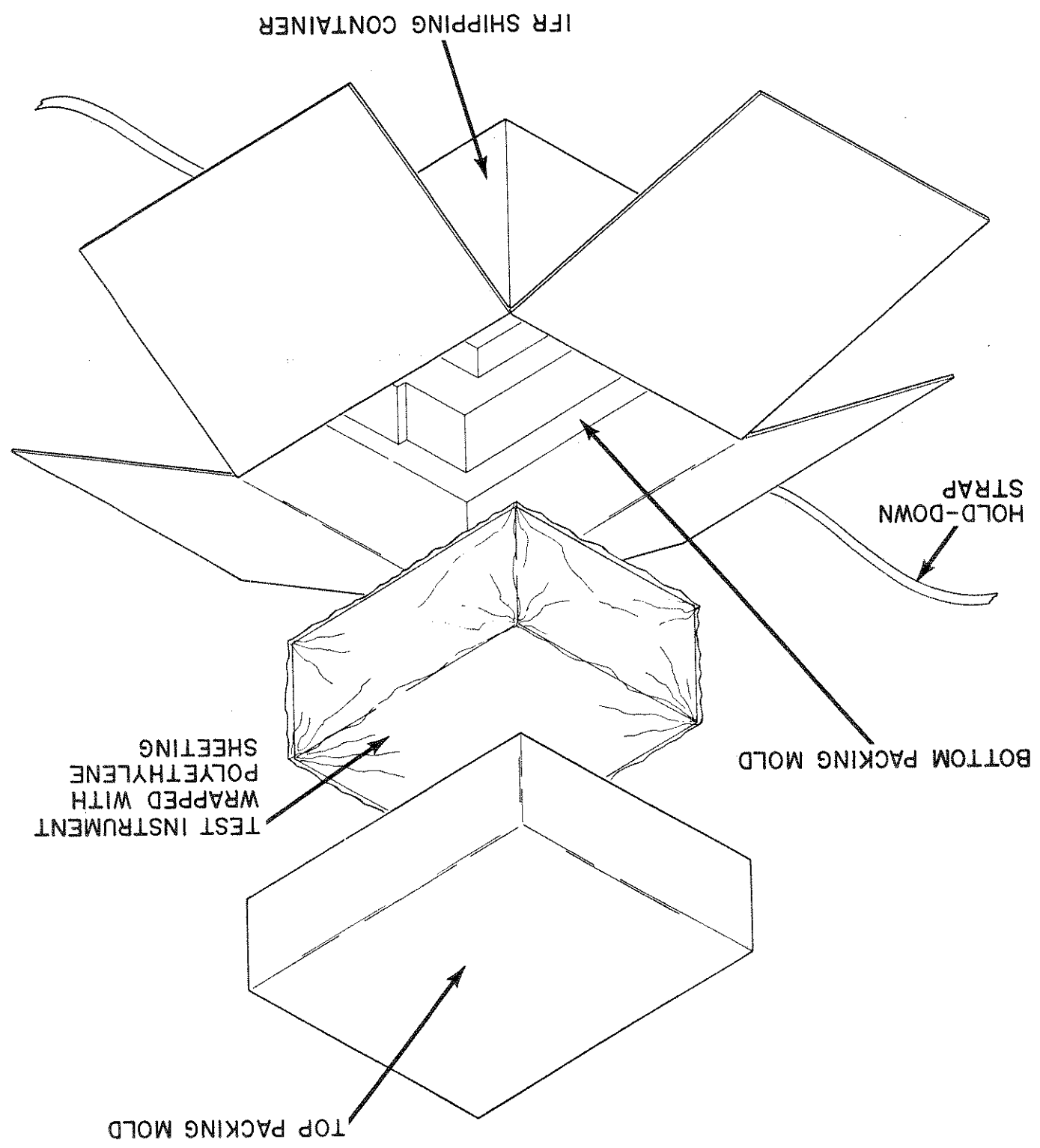

APPENDIX G - ABBREVIATIONS

Following is an alphabetical listing of abbreviations used in this manual.

AC	- Alternating Current
AC	- Automatic Calibration (also ACal or Auto Cal)
ADJ	- Adjust
AM	- Amplitude Modulation
ANSI	- American National Standards Institute
ASCII	- American Standard Code for Information Interchange
ATTEN	- Attenuation
Auto Cal	- Automatic Calibration
BAT or BATT	- Battery (Switch)
BW or B/W	- Bandwidth
CAL	- Calibration
ccw	- Counter Clockwise
CF	- Center Frequency
CISPR	- Comite International Special des Perturbations Radio-electroniques (Special International Committee for the Study of Radioelectronics Interference)
cm	- Centimeter
coax	- Coaxial Cable
COMP	- Compare (mode)
CRT	- Cathode Ray Tube
CM	- Continuous Wave
cw	- Clockwise
dB	- Decibels
dbc	- Decibels relative to carrier
dbm	- Decibels relative to milliwatts
dBmW	- Decibels relative to microwatts
dBmV	- Decibels relative to millivolts
dBuV	- Decibels relative to microvolts
dBV	- Decibels relative to volts
DC	- Direct Current
DISP	- Display (mode)
DIV	- Division(s)
EMI	- Electromagnetic Interference
EXT AMP	- External Amplifier

- FCC - Federal Communications Commission
- FILT - Filters (menu)
- FM - Frequency Modulation
- GEN - (Tracking) Generator
- GEN ATTEN - Generator Attenuation
- GHZ - Gigahertz (10⁹ Hz)
- GPIB - General Purpose Interface Bus
- HZ - Hertz
- IEEE - Institute of Electrical and Electronic Engineers
- IF - Intermediate Frequency
- K - Kilo (1,000)
- kg - Kilograms
- KHZ - Kilohertz
- LIN - Linear
- LISN - Line Impedance Stabilization Network
- LOG - Logarithm
- M - Mega- (10⁶) or Manual (Indicator)
- MHZ - Megahertz (10⁶ Hz)
- MΩ - Megohms (10⁶ Ohms)
- ms - Milliseconds (10⁻³ seconds)
- μV - Microvolts (10⁻⁶ Volts)
- mVDC - Millivolts Direct Current (10⁻³ Volts)
- n... - Unspecified numeric digit
- Ω - Ohms
- PC - Printed Circuit
- PKHOLD - Peak Hold
- ppm - Parts per million
- PWR - Power (switch)

- RAM Random Access Memory
- RCVR Receiver (menu)
- REF Reference (mode)
- RES B/W Resolution Bandwidth
- Ret Return
- RF Radio Frequency
- RID Reply Identifier
- RMS Root Mean Square
- ROM Read-only Memory
- SSB Single Side Band
- Swp Sweep (Rate)
- TC Time Constant
- TCXO Temperature Compensated Crystal Oscillator
- TSR Time Share Reception
- UUT Unit Under Test
- VAC Volts Alternating Current
- VDC Volts Direct Current
- VF Video Filter
- VRST.M. Vertical Raster Scan
- VSMR Voltage Standing Wave Ratio

